



INTERNATIONAL APPLICATION PUBLISHED UNDER THE PATENT COOPERATION TREATY (PCT)

| | | |
|--------------------------------------------------------------------------------------------------------------------------------------------------------------------------------------------------------------------------------------------------------------------------------------------------------------------------------------------------------------------------------------------------------------------------------------------------------------------------------------------------------------------------------------------------------------------------------------------------------------------------------------------------------------------------------------------------------------------------------------------------------------------------------------------------------------------------------------------------------------------------------------------------------------------------------------------------------------------------------------------------------------------------------------------------------------------------------------------------------------------------------------------------------------------------------------------------------------------------------------------------------------------------------------------------------------------------------------------------------------------------------------------------------------------------------------------------------------------------------------------|-----------|----------------------------------------------------------------------------------------------------------------------------------------------------------------------------------------------------------------------|
| (51) International Patent Classification ⁶ : H04N 7/173 | A1 | (11) International Publication Number: WO 97/50251 (43) International Publication Date: 31 December 1997 (31.12.97) |
| (21) International Application Number: PCT/US97/09703 (22) International Filing Date: 24 June 1997 (24.06.97) (30) Priority Data: 08/668,930 24 June 1996 (24.06.96) US (71) Applicants: NEWS AMERICA PUBLICATIONS, INC. [US/US]; 1211 Avenue of the Americas, New York, NY 10036 (US). TELECOMMUNICATIONS OF COLORADO, INC. [US/US]; 1519 DTC Parkway, Englewood, CO 80111-3000 (US). (72) Inventors: DAVIS, Bruce; 5505 Preserve Parkway South, Greenwood Village, CO 80121 (US). ELLIS, Michael, Dean; 1300 Kingwood Place, Boulder, CO 80304 (US). KNUDSON, Edward, Bruce; 11055 W. Rowland Avenue, Littleton, CO 80127 (US). MILLER, Larry; 35 Glenmore Drive, Greenwood Village, CO 80111 (US). (74) Agent: RIZZI, Steven, J.; Weil, Gotshal & Manges LLP, 767 Fifth Avenue, New York, NY 10153 (US). | | (81) Designated States: AU, BR, CA, CN, JP, KR, PL, European patent (AT, BE, CH, DE, DK, ES, FI, FR, GB, GR, IE, IT, LU, MC, NL, PT, SE). Published <i>With international search report.</i> |
| (54) Title: IMPROVED ELECTRONIC TELEVISION PROGRAM GUIDE SCHEDULE SYSTEM AND METHOD WITH POP-UP HINTS | | |
| (57) Abstract An electronic program schedule system which includes a receiver for receiving broadcast, satellite or cablecast television programs for a plurality of television channels and a tuner for tuning a television receiver to a selected one of the plurality of channels. A data processor receives and stores in a memory television program schedule information for a plurality of television programs to appear on the plurality of television channels. A user control apparatus, such as a remote controller, is utilized by a viewer to choose user control commands and transmit signals in response to the data processor which receives the signals in response to user control commands. A television receiver is used to display the television programs and television program schedule information. A video display generator receives video control commands from the data processor and program schedule information from the memory and displays a pop-up hint in overlaying relationship with the program schedule information in at least one mode of operation of the television programming guide. The data processor controls the video display generator with video control commands, issued in response to the user control commands, or in response to a predetermined period of user inactivity to display pop-up hints for the user's current position in the guide in overlaying relationship with the program schedule information. | | |

FOR THE PURPOSES OF INFORMATION ONLY

Codes used to identify States party to the PCT on the front pages of pamphlets publishing international applications under the PCT.

| | | | | | | | |
|----|--------------------------|----|------------------------------------------|----|----------------------------------------------|----|--------------------------|
| AL | Albania | ES | Spain | LS | Lesotho | SI | Slovenia |
| AM | Armenia | FI | Finland | LT | Lithuania | SK | Slovakia |
| AT | Austria | FR | France | LU | Luxembourg | SN | Senegal |
| AU | Australia | GA | Gabon | LV | Latvia | SZ | Swaziland |
| AZ | Azerbaijan | GB | United Kingdom | MC | Monaco | TD | Chad |
| BA | Bosnia and Herzegovina | GE | Georgia | MD | Republic of Moldova | TG | Togo |
| BB | Barbados | GH | Ghana | MG | Madagascar | TJ | Tajikistan |
| BE | Belgium | GN | Guinea | MK | The former Yugoslav Republic of Macedonia | TM | Turkmenistan |
| BF | Burkina Faso | GR | Greece | | | TR | Turkey |
| BG | Bulgaria | HU | Hungary | ML | Mali | TT | Trinidad and Tobago |
| BJ | Benin | IE | Ireland | MN | Mongolia | UA | Ukraine |
| BR | Brazil | IL | Israel | MR | Mauritania | UG | Uganda |
| BY | Belarus | IS | Iceland | MW | Malawi | US | United States of America |
| CA | Canada | IT | Italy | MX | Mexico | UZ | Uzbekistan |
| CF | Central African Republic | JP | Japan | NE | Niger | VN | Viet Nam |
| CG | Congo | KE | Kenya | NL | Netherlands | YU | Yugoslavia |
| CH | Switzerland | KG | Kyrgyzstan | NO | Norway | ZW | Zimbabwe |
| CI | Côte d'Ivoire | KP | Democratic People's Republic of Korea | NZ | New Zealand | | |
| CM | Cameroon | KR | Republic of Korea | PL | Poland | | |
| CN | China | KZ | Republic of Korea | PT | Portugal | | |
| CU | Cuba | LC | Kazakistan | RO | Romania | | |
| CZ | Czech Republic | LI | Saint Lucia | RU | Russian Federation | | |
| DE | Germany | LR | Liechtenstein | SD | Sudan | | |
| DK | Denmark | | Sri Lanka | SE | Sweden | | |
| EE | Estonia | | Liberia | SG | Singapore | | |

IMPROVED ELECTRONIC TELEVISION PROGRAM
GUIDE SCHEDULE SYSTEM AND METHOD WITH POP-UP HINTS

This application is a continuation-in-part of application serial no. 08/247,101, filed May 20, 1994, which is a continuation-in-part of application serial no. 08/119,367, filed Sept. 9, 1993.

5 Background of the Invention

This invention relates to an electronic program schedule system, which provides a user with schedule information for broadcast or cablecast programs viewed by the user on a television receiver. More particularly, it relates to an improved electronic
10 program guide that provides the user with a more powerful and convenient operating environment, while, at the same time, increasing the efficiency of navigation by the user through the guide.

Electronic program guides for television systems are
15 known in the art. For example, one prior system used an electronic character generator to display textual schedule information on the full screen of a television receiver. Other prior systems presented electronically stored program schedule information to a user for viewing while allowing the user to
20 select display formats. Still other systems employed a data processor to input user-selection criteria, then stored only the program schedule information meeting these criteria, and subsequently used the stored information to automatically tune a programmable tuner or activate a recording device at the time of
25 broadcast of the selected television programs. Such prior systems are generally discussed in "Stay Tuned for Smart TV," published in the November 1990 issue of *Popular Science*.

Collectively, the prior electronic program systems may be difficult to implement and cumbersome to use. They also fail

to provide viewing capabilities that address in a more realistic manner the viewing habits of the users of these electronic program systems. Moreover, many of these systems are complex in their design and are expensive to implement. Ease of use and economy
5 are primary concerns of television program distributors and viewers as they contemplate dramatic increases in the number and nature of program networks and other television-based services. And, as the number of television channels available to a user increases dramatically with the advent of new satellite and cable-
10 based technologies, the utility of these prior systems substantially diminishes.

These prior-art systems also fail to provide the user with sufficient information, for example pricing and the like, about pay-per-view events, premium services or other packaged
15 programming to which the user does not subscribe, nor do they provide the user with the capability to automatically purchase such programming on demand or impulse. Moreover, these prior-art systems are deficient in that they fail to provide an efficient and automatic method of updating or replacing the application
20 software programs that implement the electronic guide at the user sites, relying instead on manual or other cumbersome forms of revision or replacement or hardware-based systems that can not be updated without physical replacement of integrated circuits and/or other parts.

25 Nor do these prior electronic guide systems have the capability of linking the user to other applications or information systems which are not part of the electronic program guide application or data.

Nor do these prior electronic guide systems provide
30 video promotion of television programs and services that are functionally linked and visually displayed in an integrated fashion. Program promotion is an important element of the effective marketing of television programming. The promotion of pay-per-view pay (i.e., "a la carte") programs and other
35 unregulated program services is particularly important to cable

television operators in the wake of re-regulation by the federal government. The current method of promoting such programming using video is through dedicated "barker" channels that use full screen continuous trailers (i.e., previews) which may or may not
5 be accompanied by prices and ordering information. Recently, such promotional videos have been shown in split screens where part of the screen shows general schedule information for a time period roughly corresponding to the time period during which the general program being promoted is shown. Accordingly, there exists a need
10 for an electronic program guide which can provide improved display and linking of video promotions with program schedule information and order processing functions.

The prior electronic program guides also fail to provide the user with a simple and efficient method of controlling access
15 to individual channels and individual programs. The amount of adult situations involving sex and violence has steadily increased during the last 40 years. The issue of how this affects children or other viewers has gained national attention. Providing a parent with the ability to lock-out a channel is a well known and
20 widespread feature of certain television receivers and cable converter boxes. Despite this availability, the feature is seldom used by parents. The main impediments to its effective use are the cumbersome ways in which it is generally implemented, as well as the requirement that entire channels be blocked in order to
25 block access to any objectional programming. A channel-oriented parental lock is unfair to other programmers on the blocked channel -- who, for example, offer adult-oriented programming in the evening and youth-oriented programming the following morning-- and inconvenient for viewers who want access to such programs.
30 Thus, there is a particular need for a system which provides password control to individual programs and channels using a flexible and uncomplicated on-screen user interface.

The prior electronic program guides are also deficient in that they do not provide the user with the ability to view on
35 demand current billing status and, thus, a need exists for a

system which can provide the user with current billing information on the user's demand.

An additional problem with prior program guides is that when displaying schedule information in grid format, i.e., columns representing time slots and rows representing channels, program titles generally are width-wise truncated to fit into the cells of the grid. The width of a grid cell varies with the duration of the program. Since a 30 minute program is allotted only a small amount of space for the program title and description, titles and/or descriptions for half and even full hour programs often must be truncated in order to fit into the allotted space. Some systems simply cut off the description of a program without abbreviating it in any way, such that the user is unable to determine the subject matter of the program. For example, a recent television program display included the following text in a grid cell: "Baseball: Yankees v." Although some systems partially alleviate this problem by providing two lines of text in each grid cell, this solution is not ideal because program descriptions may still be truncated.

A similar problem arises as the time slots change, either automatically or in response to a user control command. Typically, 90 minutes of schedule information is displayed at one time and the 90 minute window is shiftable in 30-minute increments. In the case where a 30 minute shift causes a 30 minute size grid cell to display, e.g., a two-hour movie, it is likely that the full title of the movie will not fit into the cell. Truncation of the title is thus required in this situation as well. In this case, while two lines of text may be desirable to fit the title in the 30 minute cell, the 60 and 90 minute cells may require only one line of text to display the title.

The prior electronic program guides also lack a method for creating a viewing itinerary electronically while still viewing a program currently appearing on the television receiver. Moreover, these prior program guides leave much guess work for the user as he navigates through a sequence of channels. When

skimming through channels to ascertain the program then being displayed on any channel, commonly known as "channel surfing," the user needs to guess which program is currently being aired from the video encountered as the user surfs through the channels.

5 Since much -- in some cases, up to 30% -- of the programming appearing on any given channel at any given time is advertising or other commercial programming, the user is not provided with any clues as to what program is appearing on a selected channel at a given time and must therefore wait until the advertisement or

10 commercial is over before ascertaining the program then appearing on the selected channel. Thus a need exists for a program guide which displays current program schedule information for each channel as the user surfs through the available channels.

Prior electronic program guides are also deficient in

15 that they do not provide the user with appropriate and unobtrusive guidance as to what actions may be taken at different points in the guide. When using an electronic program guide, the user may reach a screen or manoeuver the cursor to a state where the user is uncertain what actions may be taken. Prior guides either do

20 not have any facility to provide the user with guidance, or they require that the user explicitly ask for help by, e.g., pressing a help button. If the guide requires the user to explicitly ask for help, and the user is not aware that help is available, the user may be confused or unsure how to obtain assistance in

25 operating the guide. If the system does not provide on-screen help, the user must search through cumbersome and complicated manuals that are often confusing and not helpful or are lost or not readily available.

In addition, electronic program guides that do provide

30 context-sensitive on-screen assistance often require that the user leave the task he or she is performing (operating the guide), overlaying the image with the help information. This feature may be cumbersome in that the user must exit the help screen before executing a command suggested by the help information. These

35 guides provide no facility whereby the user can execute a command

while the help information is displayed on the screen. These prior guides also do not automatically provide help in response to inactivity or improper key-strokes by the user, requiring that the user know that on-screen help is available. This can frustrate
5 users who are unfamiliar with the operation of the guide and unaware of the existence of on-screen help.

Known in the art of computer games, and in particular games involving characters moved through scenes under control of the player, are prompts that appear on screen if the player stalls
10 for a certain amount of time. In this situation, the game assumes that the player is in need of assistance with regard to possible actions to take at that point in the program. The system then prompts the player what action or actions to take to provide assistance in progressing through the scene.

15 However, current application software programs, like electronic program guides, lack adequate help features in several respects. In general, such programs do not provide for user hints based on a period of inactivity in defined contexts within the program. As such programs are constantly increasing in
20 complexity, there is a need to provide the user with hints where, based on a predetermined period of user inactivity, the program determines that the user has reached a point in the program where he or she is unsure of what to do.

Accordingly, there is a need in the art for a simplified
25 electronic program schedule system that may be more easily implemented, and which is appealing and efficient in operation. There is also a need to provide the user with an electronic program schedule system that displays both broadcast programs and electronic schedule information in a manner not previously
30 available with other electronic program schedule systems, particularly those using a remote controller.

For example, there is a particular need for a flexible program schedule system that allows a user to view selected broadcast programs on a portion of the screen of the television
35 receiver while simultaneously viewing program schedule information

for other channels and/or services on another portion of the screen. There is also a need for such a program schedule system that permits the user to select from a plurality of selectable display formats for viewing the program schedule information. It is also preferred to have a system that indicates to the user those keys on the remote controller that are active in any particular mode of operation. There also exists a need for such a system that will give a user the capability to set a programmable reminder for viewing a program scheduled to air at a future time.

There is also a need for an electronic guide system providing the user with comprehensive information about pay-per-view events, premium services or other packaged programming to which the user does not ordinarily subscribe, and which provides the user with the capability to automatically purchase such programming on demand or impulse. There is also a need for an electronic guide system providing a reliable and efficient method of updating or replacing the application software that implements the electronic guide at the user sites.

There also exists a need for an electronic program guide that operates as a shell or window to provide the user with the capability to access other applications or information systems that are not part of the electronic program guide application or data.

There also exists a need for an electronic program guide that detects when a user is in need of assistance and provides assistance that is both appropriate and unobtrusive.

It is accordingly an object of the present invention to provide a system that will allow the user to view a broadcast program while, at the same time, interactively viewing program schedule information for other programs.

It is another object of the present invention to provide the user with the ability to select from among a plurality of display formats for the program schedule information.

It is yet another object of the present invention to indicate to the user of the program schedule system those keys on the remote controller active in the particular mode of operation of the system at the time of use.

5 It is a still further object of the present invention to provide the user of the electronic program schedule system with the capability of setting programmable reminder messages for any future program.

10 It is yet a further object of this invention to provide the system user with comprehensive information about pay-per-view events, premium services or other packaged programming to which the user does not subscribe and the capability to automatically purchase such programming on demand or impulse.

15 It is another object of the present invention to provide an electronic guide system that provides a reliable and efficient method of updating or replacing the application software programs that implement the electronic guide at the user sites.

20 It is still another object of the electronic program guide to operate as a shell or window to provide the user with the capability to access other applications or information systems which are not part of the electronic program guide application or data.

It is yet another object of the electronic program guide to provide a system whereby video promotion of television programs and services are functionally linked and visually displayed in an integrated fashion to facilitate the marketing and sale of such programs and services.

30 It is still a further object of the present invention to provide password control for access to individual programs, as well as channels, using a protected interactive flexible and uncomplicated on-screen interface.

Another object of the present invention is to provide the user with current programming information for all programs as the user surfs through the available channels.

It is yet a further object of the present invention to provide a system in which the user can access his current billing information on demand.

It is another object of the present invention to provide
5 a system which overlays television program listings against varying background views.

It is yet another object of the present invention to provide an improved display of text in the grid cells comprising a page of television program listings.

10 It is another object of the present invention to provide the user with assistance in operating the program guide in an appropriate and unobtrusive manner.

It is a further object of the present invention to provide an improved help feature for applications software
15 programs where the program determines that the user may be in need of assistance based on a period of inactivity within a defined context.

These and other objects of the invention are achieved by an electronic program schedule system which includes a receiver
20 for receiving broadcast, satellite or cablecast television programs for a plurality of television channels and a tuner for tuning a television receiver to a selected one of the plurality of channels. A data processor receives and stores in a memory television program schedule information for a plurality of
25 television programs to appear on the plurality of television channels, and program control information to control the operation of the program schedule system. A user control apparatus, such as a remote controller, is utilized by a viewer to choose user control commands and transmit signals in response to the data
30 processor which receives the signals in response to user control commands. A television receiver is used to display the television programs and television program schedule and other information. A video display generator receives video control commands from the data processor and program schedule information from the memory
35 and displays a portion of the program schedule information in

overlying relationship with a television program appearing on a television channel in at least one mode of operation of the television programming guide. The data processor controls the video display generator with video control commands, issued in response to the user control commands, to display program schedule information for one or a plurality of television programs on the television receiver in accordance with one of a plurality of user-selectable modes. The data processor also controls the video display generator with video control commands, issued in response to the user's commands or inaction, to display help information in response to the current cursor position simultaneously with display of the program guide.

In accordance with a further aspect of the invention, the video display generator receives video control commands from the data processor and program schedule information from the memory and displays "pop-up" hints in overlying relationship with the program schedule information in at least one mode of operation of the television programming guide. The pop-up hints comprise information or possible user control commands. The data processor controls the video display generator with video control commands, issued in response to the user control commands, or in response to a predetermined period of user inactivity to display pop-up hints for the user's current cursor position in overlying relationship with the program schedule information.

25

Brief Description of the Drawings

Fig. 1 is a block diagram showing various components of the preferred embodiment of the invention herein.

Fig. 2 is a block diagram showing the combination of program and schedule information by the video overlay device utilized in the preferred embodiment of the invention.

Fig. 3 depicts a remote controller that can be used in connection with the preferred embodiment of the electronic program guide system of the present application.

Fig. 4 depicts an alternative embodiment of the remote controller shown in Fig. 3.

Fig. 5 shows an overlay appearing on a television screen in one mode of operation of the preferred embodiment of the present invention.

Fig. 6 is a menu that appears on a television screen in a MENU mode of operation of the preferred embodiment of the present invention.

Fig. 6A is yet another menu that appears on a television screen in a MENU mode of operation of the preferred embodiment of the present invention.

Fig. 7 depicts a Viewer Preference Menu that appears on a television screen in one aspect of the preferred embodiment of the present invention.

Fig. 8 shows a Preferred Channel selection submenu.

Fig. 9 shows an impulse ordering menu that appears on a television screen in one aspect of the preferred embodiment of the present invention.

Fig. 10 shows a Premium Services submenu that appears in one mode of operation of the preferred embodiment of the present invention.

Fig. 11 shows a graphic overlay appearing on a television screen in a BROWSE mode of operation of the preferred embodiment of the present invention.

Fig. 12 shows a graphic overlay appearing on a television screen in a BROWSE mode of operation of the preferred embodiment of the present invention having different information from that shown in Fig. 11.

Fig. 12A shows a graphic overlay appearing on a television screen in a BROWSE mode of operation in the present invention displaying schedule information for a time and channel other than that shown in Fig. 11.

Fig. 13 shows a graphic overlay appearing in a REMINDER mode of operation of the preferred embodiment of the present invention.

Fig. 14 shows yet another graphic overlay appearing in a REMINDER mode of operation of the preferred embodiment of the present invention.

Fig. 15 is yet another menu that appears on a television screen in a MENU mode of operation of the preferred embodiment of the present invention.

Fig. 16 is yet another menu that appears on a television screen in a MENU mode of operation of the preferred embodiment of the present invention.

10 Fig. 17 is yet another menu that appears on a television screen in a MENU mode of operation of the preferred embodiment of the present invention.

Fig. 18 shows a grid listing of schedule information displayed in an All Listings mode of operation of the preferred 15 embodiment of the present invention.

Fig. 19 shows schedule information displayed in a Listings By Category mode of operation of the preferred embodiment of the present invention.

Fig. 20 shows schedule information displayed in a 20 Listings By Channel mode of operation of the preferred embodiment of the present invention.

Fig. 21 shows information displayed in response to a user's request for supplemental programming information.

Fig. 22 shows programming, ordering and video 25 promotional information displayed in a Pay-Per-View mode of operation of the preferred embodiment of the present invention.

Fig. 23 shows an ordering submenu used in conjunction with the mode of operation shown in Fig. 22.

Fig. 24 shows yet another ordering submenu used in 30 conjunction with the mode of operation shown in Fig. 22.

Fig. 24A shows yet another ordering submenu used in conjunction with the mode of operation shown in Fig. 22.

Fig. 25 shows another grid listing of schedule information displayed in an All Listings mode of operation of the 35 present invention.

Fig. 26 shows a Premium Services submenu that appears in one mode of operation of the preferred embodiment of the present invention.

Fig. 27 shows a Messages menu that appears in one mode of operation of the preferred embodiment of the present invention.

Fig. 28 shows exemplary messages used in connection with the menu of Fig. 27.

Fig. 28A is an alternative message menu.

Fig. 29 shows billing information used in connection with the menu of Fig. 27.

Fig. 30 shows a Key Lock Access menu that appears during one mode of operation of the preferred embodiment of the present invention.

Fig. 31 shows a menu appearing in connection with an Interactive Television mode of operation of the preferred embodiment of the present invention.

Fig. 32 shows information that appears in a Quote Watch menu in connection with the Interactive Television mode of operation shown in Fig. 31.

Fig. 33 shows other information that appears in connection with the Interactive Television mode of operation shown in Fig. 31.

Fig. 34 is a menu showing information that appears in a news display in the Interactive Television mode of operation of the preferred embodiment of the present invention.

Fig. 35 is a menu showing information that appears in a sports display in the Interactive Television mode of operation of the preferred embodiment of the present invention.

Figs. 36A-D are a flow chart showing the operation logic required for implementation of a computer program for the electronic program guide.

Fig. 37 is a menu showing a Locator screen for locating channel numbers and defining favorite channel lists.

Fig. 38 is an alternative menu that can be used in a MENU mode of operation of the electronic program guide.

Fig. 38A and 38B show, respectively, an alternative main menu screen and a listing-by-time screen accessible from the alternative main menu.

Fig. 39 is a Lockout menu that alternatively can be used for permitting or prohibiting access to certain programs.

Fig. 40 is a Setup menu that can be used to set text location and a purchase code for premium and pay-per-view programming.

Fig. 40A shows an exemplary menu for inputting a lockout code.

Figs. 40B through 40E show, respectively, exemplary menus for entering, confirming, clearing or changing a purchase code.

Fig. 41 is a Lockout Verify menu that is used in connection with the Lockout menu of Fig. 39.

Fig. 42 is a flow chart showing the operation of the preferred embodiment of the textfit system of the invention herein.

Figs. 43A through 43I show exemplary hints showing choices available on the Listing By Time screen in the preferred embodiment of the invention.

Figs. 44A and 44B show exemplary hints in two different modes of operation of the guide in the preferred embodiment of the invention.

Figs. 45A through 45C show additional exemplary hints on, respectively, the lock, change times, and view by title screens of the guide in the preferred embodiment of the invention.

Fig. 46 is a flow chart illustrating the operation of one embodiment of the system to display and cycle through context sensitive hints of the invention herein.

Fig. 47 is a flow chart illustrating the operation of another embodiment of the system which uses the previous command in determining which hints to display.

Fig. 48 is a setup screen in the preferred embodiment of the invention that may be used to control the display of context sensitive hints.

Fig. 49 shows an exemplary hint in an alternate 5 embodiment of the invention implemented in a personal computer application program.

DETAILED DESCRIPTION OF THE PREFERRED EMBODIMENT

System Configuration

Fig. 1 is a block diagram showing various components of 10 the electronic program schedule system generally designated as 10. Physically, these system components can be located in a user's set-top cable converter box or other signal reception or processing device, such as a satellite receiver. Alternatively, the components can be mounted in a separate housing, or included 15 as part of a television receiver, VCR, personal computer, or multimedia player; or reside as a distributed application in a broadband network architecture.

An input signal 11 is connected to a receiver 12, which receives a transmitted data stream from a data provider. The data 20 stream may contain, for example, information about programs or services available in a particular market, geographical or otherwise. The input signal 11 can originate, for example, as part of a standard broadcast, cablecast or satellite transmission, or other form of data transmission. The data provider is a 25 program information provider, the satellite uplink manager, a local cable operator, or a combination of these sources, and the data stream contains program schedule information for all television programs and other services available in the operator's geographical market.

30 The data stream may be modulated and then transmitted on the cable line in any number of ways, including as part of a dedicated channel transmission operating at a frequency of, for example, 75 MHz. Those of skill in the art will understand that numerous other transmission schemes can be used to transmit the 35 data stream, such as embedding it in the vertical blanking

interval of a program broadcast signal. As will be discussed in greater detail below, according to the present invention, the transmitted data stream may additionally contain application software for implementing or updating the electronic program guide at the user site.

The transmitted program schedule data or application software is received by the receiver 12 on signal input line 11. The received signal is passed from the receiver to a data demodulator 13, such as a QPSK demodulator or a GI Info-Cipher 10 1000R, which demodulates the transmission and passes it to a buffer 15.

A microcontroller 16, such as a M68000EC, receives data passed to the buffer 15. Bootstrap operating software, which may be used for capturing electronic program guide application software updates, is stored in a read only memory (ROM) 17. The microcontroller 16 uses the received program schedule information to build a database by storing the data in appropriately organized records in dynamic random access memory (DRAM) 18. The stored schedule information can be updated on a periodic basis, such as 20 hourly, daily or weekly, or at any time when changes in scheduling or other factors warrant an update. The system also includes a system clock 19 which may be used as a timer to determine elapsed time between, e.g., user commands. Those of ordinary skill in the art will recognize that other timing means may be substituted for 25 a system clock.

Alternatively, the program schedule information could be supplied in a ROM, disk or other non-volatile memory, or it could be downloaded to a storage disk or other data storage device. The invention herein is not directed to the particular method of 30 transmission or reception of the schedule information.

If the microcontroller 16 recognizes the received data as application software which controls the program schedule system, as opposed to program schedule information, it stores it in non-volatile memory, such as an electrically erasable 35 programmable ROM (EEPROM) 20 or battery-backed static RAM (SRAM).

This configuration allows revised or replacement versions of the application software to be downloaded directly from the software developer to the user site through the cable or other transmission system.

5 In the case where an EEPROM is utilized, revised or replacement versions of the application software downloaded from the developer are first stored in DRAM 18 by the microcontroller 16, under direction of the downloading operating software stored in the ROM 17. The stored application software can then be
10 checked for accuracy by, for example, a checksum analysis or other verification routine.

 After the accuracy of the application software has been verified, the microcontroller 16 initiates a routine to re-program the EEPROM 20, where the application software is permanently
15 stored. The microcontroller 16 will issue proper control commands to a reprogram circuit 21, which is adapted to supply the proper program voltage and logic control signals 22 required to erase and write to the EEPROM. It supplies this program voltage, Vprog, as well as any other required control signals, such as read or write
20 enable, to the EEPROM 20 upon command from the microcontroller 16. After the EEPROM 20 has been electrically erased, the microcontroller 16 initiates transfer of the new application software from the DRAM 18 to the EEPROM 20 for storing.

 When a battery-backed SRAM is utilized as non-volatile
25 memory, the microcontroller stores the revised or replacement version of the application software downloaded from the developer directly in the SRAM, again under direction of the downloading operating software stored in the ROM. The stored application software can then be checked for accuracy by, for example, a
30 checksum analysis or other verification routine.

 When power is first applied to the system 10, the bootstrap operating software verifies that the program guide application software is resident in memory. If it is not resident, the bootstrap operating software waits for a download of
35 the software. Once the application software is resident, the

microcontroller 16 executes the application program software from a dedicated portion of the DRAM 18. Alternatively, the application software can be executed directly from the non-volatile memory 20. Under control of the program guide
5 application software, the microcontroller 16 first verifies that the program schedule information is resident in DRAM 18. If it is not resident, the microcontroller waits for a download of the program schedule information, as discussed above. Alternatively, if the application program is resident in memory, but the database
10 records containing the program schedule information data are not yet available, the application software can be configured to carry out other tasks, such as allowing the user to carry out functions not requiring the program schedule information data, as well as displaying an appropriate message indicating the database data is
15 not yet available.

When the schedule system is operating, as discussed in greater detail hereinbelow, the microcontroller 16 takes the program schedule information stored in the DRAM 18 and, in conjunction with other downloaded data types such as stored bit
20 maps for the screen configuration and the graphic symbol or logo displays stored in non-volatile memory 20 or, alternatively, in DRAM 18, supplies it to a video display generator (VDG) 23, which in the present embodiment may be a commercially available VGA-type graphics card, such as a Rocgen card manufactured by Roctec. The
25 VDG includes a standard RGB video generator 24, which takes the digital program schedule information sent by the microcontroller 16 and converts it to an RGB format in accordance with the bit map for the particular screen display then being presented to the user on the television receiver 27. The configuration of each screen
30 is shown and discussed in greater detail in the System Operation section below.

The VDG also includes a Video Overlay Device 25, which accepts the RGB video input, as well as an input from conventional television tuner 28, such as a conventional tuner
35 manufactured by General Instrument or a Jerrold DPBB tuner, which

supplies a program signal in standard NTSC video format. The overlay device 25 converts and combines the RGB signal with the signal from the tuner 28, and produces a composite NTSC output signal containing both the program signal and the program schedule 5 information, as shown in Fig. 2. This composite video signal is supplied to a modulator 26, shown in Fig. 1, which can be a modulator such as available from Radio Shack, and then to the television receiver 27, which the user keeps tuned to the modulated channel, for example, channel 3 or 4. The composite 10 video signal can also be supplied directly to the television receiver 27 or other receiving device from the VDG through a video port 25A on the VDG.

In an alternate embodiment of the program guide system and method of the present invention, in addition to utilizing 15 stored data for generating screens for display on a television receiver, audio data related to the operation of the guide may be stored in memory. Those of ordinary skill in the art will recognize that a program guide utilizing such locally stored audio information may require additional memory capacity for storage of 20 the data. A system with audio capability will additionally require an audio signal generator operating in conjunction with the VDG 23. Such an audio signal generator may also be controlled by the microcontroller 16 and provide its output to modulator 26 for presentation using tv receiver 27. Those of ordinary skill in 25 the art will also recognize that a multimedia generator with both audio and video signal generation capabilities may be used rather than separate audio and video generators. Audio messages may be stored by digitizing an analog audio signal or, alternatively, stored text data may converted to audio messages if the audio 30 signal or multimedia generator includes speech synthesis capabilities. As discussed in greater detail below, stored audio messages may be used to assist the user in the operation of the program guide.

If the system uses an audio generator or a multimedia 35 generator, the audio portion of the display signal is overlaid

with the audio portion of the input from the conventional television tuner 28. In performing this audio overlaying function, the volume of the signal received from the tuner may be attenuated to emphasize the overlaid audio signal. The modulator 5 then modulates this audio signal along with the composite NTSC output signal to create the modulated signal. As discussed below, in several modes of operation of the program guide, the signal output to the television receiver consists solely of the output of the VDG 23 (and the audio generator if one is present) or 10 multimedia generator.

The system components identified in connection with Fig. 1 can all be implemented in a preferred platform by, for example, an IBM personal computer equipped with a transmission link and a video graphics card, such as those manufactured by Roctec. Other 15 platforms, such as a cable converter box equipped with a microprocessor and memory, or a broadband network also could be used. Examples of the particular components are as follows: Microcontroller -- Motorola part no. MC68331-16; ROM -- Texas Instruments part no. TMS27PC512; DRAM -- Texas Instruments part 20 no. TM4256; EEPROM -- Intel part no. 28F001BX-T. In any event, those of skill in the art will appreciate that the particular details of the hardware components and data storage are a function of the particular implementation of the system, and are not the subject of the present invention.

25 As discussed in detail below, the user may navigate through the program schedule system with a remote controller, such as that shown in Fig. 3, which operates on conventional principles of remote control transmitter-receiver logic, such as by infrared or other signalling, or other suitable user interface. The remote 30 controller 31 communicates with the microcontroller 16 through the remote controller receiver 29, shown in Fig. 1, which can be a Silent Partner IR receiver and which receives signals transmitted by the remote controller 31 and supplies the microcontroller 16 with a corresponding digital signal indicating the key depressed 35 by the user.

A remote controller suitable for the present invention, such as shown in Fig. 3, which can be a remote controller manufactured by Universal Electronics or Presentation Electronics' Silent Partner, may include a power switch 32, volume 33 and mute 5 34 controls, an ENTER key 35, 0-9 digit keys 36, four direction arrow keys 37A and 37B, a MODE key 38 and an information key 39 that is designated with a lower case "i." The power 32, volume 33 and mute 34 keys operate in the same manner as conventional remote controllers typically used with present-day television receivers. 10 The numeric digit keys 36 also function in much the same manner as conventional remote controllers. A brief description of the remaining keys follows.

The MODE key 38 takes the user through various layers of the electronic program schedule system 10 and generally allows the 15 user to return to a previous screen when he is in a submenu. The up/down direction arrow keys 37A allow a user to navigate through the different TV program channels when the program schedule system is in a FLIP or BROWSE mode, as will be fully described below, and also allow the user to navigate through highlighted bars displayed 20 on the TV screen when in a MENU mode. The left/right direction arrow keys 37B allow the user to navigate through selected time periods when the program schedule system is in the BROWSE mode, as will also be described below. They further allow the user to navigate across subject-matter categories while in the 25 "Categories" submenu of the MENU mode, as well as to navigate across time periods when the program schedule system is in a pay-per-view ordering mode and, in general, navigate in left or right directions to select various icons and other objects. The information, or "i," key 39 allows the user to view supplemental 30 program and other information during the various modes of the program schedule system. The ENTER 35 key fulfills and inputs a command once the user has made a selection from the remote controller keys. The function and operation of these keys will be made more apparent in the detailed discussion of the FLIP, BROWSE 35 and MENU modes below.

A second embodiment of the remote controller 40 is shown in Fig. 4. This embodiment of the remote controller also includes a power key 41, numeric digit keys 42, direction arrow keys 43A and 43B, information key 48, ENTER or SELECT or "OK" key 44, 5 volume control 45, lockout key 45A, mute keys 46 and help key 50. It also includes pound sign and star keys.

This embodiment of the remote controller further includes a number of icon keys 47A and 47B, which correspond to different submenus or modes of the program schedule system. The 10 icons 47A and 47B may also be displayed on the TV screen when the program schedule system is operating. The icon keys essentially replace the MODE key 38 used in the embodiment of the remote controller shown in Fig. 3. Using these keys, the user can move from one mode to another simply by depressing the icon key 15 corresponding to the desired mode of operation of the program schedule system. In the embodiment of Fig. 4, the icons 47A and 47B are shown as graphic symbols situated directly above a corresponding color-coded key. Alternatively, the color-coded keys could be eliminated and keys could be formed in the image of 20 the icon itself.

The embodiment of the remote controller shown in Fig. 4 also includes three color-coded viewer preference or favorite channel keys, 48A, 48B and 48C that are situated directly above the icon keys. Each of these keys indicates to the program 25 schedule system a distinct user-created "Channel Preference" or "Favorite Channel" list, which is a listing of a specific subset of channels for a particular user, arranged in the sequential order that the user wishes to view during operation of the program schedule system. The creation of the Channel Preference or 30 Favorite Channel list is discussed in the following section. Thus, the system provides for at least three individual channel subsets for three individual users.

The remote controller of Fig. 4 also may be equipped with a "HELP" key 50, which, when depressed, causes the 35 microcontroller 16 to retrieve previously stored instruction

messages from memory and cause them to be displayed on the television receiver 27. These messages offer help to the user in the form of instructions that guide the user through the operation of the various operating modes of the electronic television program guide. They may be text messages, or instructional video images, or audio programs or messages, depending on the storage capacity of the system, or any combination of these. Moreover, these help messages may be created so that they are context-sensitive, i.e., the messages displayed depend entirely upon the precise point in the operation of the electronic program guide that the user depresses the help key 50. For example, information could be supplied for operation of the remote controller, for operating the FLIP or BROWSE mode (discussed below), or any other mode of operation of the guide, for impulse ordering, for setting a lockout, etc. In order to accomplish this, each point of operation of the guide could be coded so that the microprocessor could track the current operating point, for example, by temporarily storing the code reflecting the present operating point as the user operated the guide. When the user pressed the help key 50, the microcontroller 16 would retrieve an appropriate set of messages based on the presently stored operating point code. The help key 50 could also be used to instruct the system to display a "pop-up" hint or to cycle through available "pop-up" hints that would provide the user with guidance as to what commands may be executed at any time. Such "pop-up" hints are further described below. Additionally, the i key 39 could be used to carry out the function of the help key.

Additionally, each of the functions of the remote controllers can also be integrated into a keypad on the user's cable box or other hardware.

System Operation

In operation, the electronic program schedule system of the present invention functions as follows.

FLIP Mode

When the user is viewing a particular program channel on the television receiver, the program schedule system defaults to a FLIP mode, shown in Fig. 5. In this mode, a graphic overlay 51 containing programming information for the channel currently tuned on the tuner is superimposed in overlaying relationship with a received program signal 55 on the screen of the television receiver 27 whenever the viewer changes the program channel, for example, by using the up/down direction arrows on the remote controller. The video overlay device 25, such as shown in Fig. 1, combines the computer-generated RGB video-graphic overlay information with the NTSC-format program signal from the tuner 28, and supplies an NTSC-format output signal, which includes the program signal from the tuner and the program schedule overlay information for viewing on the television receiver 27.

The programming information contained in the graphic overlay 51 is supplied to the RGB video generator by the microcontroller. In FLIP mode, the microcontroller first searches the program schedule database in, for example, the DRAM 18 to retrieve the programming information for the currently tuned channel 52 corresponding to the current time; i.e., the time at which the user just turned on the television receiver for viewing. The microcontroller 16 then supplies the current channel and program information to the RGB video generator 24 which converts the digital data information to RGB format and supplies it to the video overlay device 25.

In normal operation, the microcontroller 16 defaults to displaying all channels offered by the cable company prioritized by numeric order, which is determined by the broadcast channel position in the radio spectrum or the marketing judgments of local cable operators. Using a "Channel Preference" submenu, or an alternative "Locator" screen, both of which are discussed below, the user can revise the content and/or sequential order of the channels presented to the television receiver 27.

In general, if the user does not issue a change-channel instruction, or other command, from the remote controller 40 within a predetermined time interval while in the FLIP mode, the microcontroller 16 instructs the VDG 23 to remove the graphic overlay 51 from the television receiver, thus presenting only a program signal 55 to the television receiver 27 for viewing. The duration of the predetermined time interval is such that it allows the user sufficient time to read the programming information contained in the overlay. The duration of the predetermined time interval during which the graphic 51 overlay appears is stored in a location in non-volatile memory 20 addressable by the microcontroller 16. The user can change the duration of the time interval, by first entering a Viewer Preference mode, and then selecting an "overlay interval" entry. The microcontroller 16 then causes a user prompt to be displayed on the screen which, for example, asks the user to select an appropriate time period for displaying in the graphic overlay on the screen. Using the numeric keys, the user can input an appropriate response, for example, a period between 5 and 60 seconds, and then depress ENTER. The new interval period is then read and stored by the microcontroller 16 in the overlay time interval location in memory.

If the user issues a change-channel command from the remote controller 40 before or after the predetermined overlay period has elapsed, either by using the up/down direction arrows 43A, or by entering a desired channel number using the numeric keys 42 and then depressing the ENTER key 44, the microcontroller 16 will cause the tuner 28 to tune to the desired channel -- either the channel immediately preceding or following the current channel when the up or down arrow 43A is used or the specific channel entered on the numeric key pad by the user -- and will also search for and immediately cause to be displayed the current program information for that channel. Thus, as the user flips through the channels, the program schedule information for any selected channel automatically appears in the graphic overlay 51

while the actual program 55 appearing on the selected channel at the particular time occupies the remainder of the screen.

The system can also be configured to issue an error message, such as an audible beep or displayed text indicating an invalid key stroke, if the user depresses either the left or right direction arrow keys while in the FLIP mode.

BROWSE Mode

To initiate the BROWSE mode, the user depresses the MODE switch once while in the FLIP mode when using the first embodiment of the remote controller 31 shown in Fig. 3. Utilizing the second embodiment of the remote controller 40 shown in Fig. 4, the user would depress the button below the BROWSE icon 47A.

In the BROWSE mode, the user is provided with the ability to scan through program schedule information for any channel, including, but not limited to, the channel being viewed, while at the same time continuing to view the TV program previously selected. As shown in Fig. 11, in this mode the graphic overlay information that appears in the FLIP mode is replaced with programming information for the channel being browsed, which may or may not be the channel currently being viewed by the user. After the user issues the command from the remote controller 40 to enter the BROWSE mode, a graphic overlay 111 is generated, as in the FLIP mode, with program schedule information for the currently tuned channel 112 and a textual BROWSE indicator 113 to remind the user of the currently active mode, as shown in Fig. 11.

If the user depresses either the up or down direction arrow on the remote controller 40 while in the BROWSE mode, program schedule information for either the prior or next channel is displayed in the graphic overlay portion 111 of the television receiver screen 27, while the tuner remains tuned to the channel program that appeared on the television receiver at the time the user entered the BROWSE mode, as shown in Fig. 12, and continues to so appear. Each successive depression of the up or down

direction arrow key produces corresponding program schedule information for the selected channel. The graphic overlay may also include a small video window for showing the actual video signal of a currently aired program or a clip of a future program
5 corresponding to the schedule information then appearing in the BROWSE overlay. In this way, the user can simultaneously scan program schedule information for all channels while continuously viewing at least one selected program on the television receiver. With the advent of sophisticated television receivers, it may also
10 be possible to simultaneously display multiple broadcast programs on a single screen for viewing, or to split the screen to show, for example, broadcast programs in combination with advertisements. The BROWSE feature could be used in any of these situations.

15 If, at any time during scanning of the program schedule information in the BROWSE mode, the user desires to tune the television receiver 27 from the program channel currently being viewed to the program channel indicated in the schedule information in the graphic overlay, he simply depresses the ENTER
20 button 44 and the tuner 28 will be tuned to that channel. If the user does not want to view another channel and wishes to exit the BROWSE mode, thus removing the graphic overlay 111 with the program schedule information, he must depress the MODE key twice in the first embodiment of the remote controller 31. The first
25 depression of the MODE key takes the user to the MENU mode, discussed below, and the second depression will take the user to the FLIP mode. Once in the FLIP mode, the graphic overlay will be removed after the duration of the time-out interval has passed. In the second embodiment of the remote controller shown in Fig. 4,
30 the user toggles the BROWSE icon key to deactivate the BROWSE mode.

When the user first enters the BROWSE mode and begins scanning channels, the schedule information appearing in the overlay portion 111 describes the programs currently playing on
35 any particular channel. In order to view programming information

for later or earlier times, the user employs the left and right direction arrows 43B. As a consequence, the system will display future program schedule information for the particular channel previously selected by the up and down direction arrows, whether 5 it is the channel currently being viewed or any other available channel. The schedule information presented includes the name of the program and program start/stop time. The instant embodiment of the system, in order to conserve memory, will not allow the user to view programming information for a time prior to the 10 current time. The system could be easily modified to provide such information if adequate memory is made available. It may be desirable, for example, to allow a user to view schedule information for an earlier time to find a particular show and then allow the user to command the microcontroller to find and display 15 future airing dates of the show, or the microcontroller could simply do this automatically.

When viewing program schedule information for a future time in the BROWSE mode, the displayed time of airing 121 of the particular show 122 is highlighted, as well as the channel number 20 and service indicator 123, as shown in Fig. 12A. Such highlighted information reminds the user that he is viewing program schedule information for a future time. Also, when viewing program schedule information for a future time on any particular channel in the BROWSE mode, depression of the channel up direction arrow 25 key on the remote controller 40 causes programming schedule information for the next channel to appear, which corresponds in time to the future time that was being viewed before the up key was depressed by the user. The channel down direction arrow key 43B functions identically in this mode.

30 If while viewing program schedule information for a future time in BROWSE mode the user depresses the ENTER key on the remote controller, the microcontroller 16 will instruct the VDG 23 to display a REMINDER overlay message 130 which, as shown in Fig. 13, is displayed as a second overlay 131 appearing above the 35 BROWSE overlay 132. The REMINDER message 130 queries the user as

to whether the system should remind the user, at a predetermined time before the start of the selected program, that he or she would like to view the selected program, as shown in Fig. 13. If the user responds affirmatively, the microcontroller 16 stores 5 reminder data consisting of at least the channel, time and day of the selected program in a reminder buffer, which contains similar schedule information for all programs for which the user has set a reminder. At a pre-determined time before the selected program start time, for example, five minutes, the microcontroller 16 will 10 retrieve schedule information, including title and service, based on the reminder data, and will instruct the VDG 23 to display a REMINDER overlay message 140 on the television receiver 27, as shown in Fig. 14, to remind the user that he or she previously set a reminder to watch the selected program. The REMINDER message 15 140 contains the channel, service and start time. It also displays the number of minutes before the time of airing of the particular show and updates the display every minute until the time of airing. The REMINDER message 140 also displays a "TUNE" inquiry, which asks the user if she would like to tune to the 20 selected program. When the user sets multiple reminders, the reminder overlays are stacked, for example, in ascending order according to the time each reminder is scheduled to be displayed, and the next reminder message will appear on the television receiver after the user takes appropriate action to remove the 25 reminder message then being displayed. The REMINDER message (140 could also be adapted to allow the user to display or modify a list of all reminders previously set by the user. As with the overlay display time period in the FLIP mode, the user can modify the time period before a selected program that the REMINDER 30 message appears by entering the Viewer Preference mode and revising the time entry.

MENU Mode

Using the remote controller 31 shown in Fig. 3, the user can enter the MENU mode from the BROWSE mode or from the FLIP mode by toggling the MODE button 38 once or twice, respectively. Using the remote controller 40 of Fig. 4, the user would simply depress the key 47B corresponding to the MENU icon.

Referring to Fig. 6, in the MENU mode, the system displays a plurality of menu items and icons, which correspond to and allow user selection of distinct program schedule information display formats, local cable system message boards and other on-line information services. The MENU screen shown in Fig. 6 is a full-screen display. In the embodiment shown in Fig. 6, there are four vertically selectable horizontal bars 61-64, which are accessed using the up and down direction arrows 43A on the remote controller 31 or 40. At the extreme left of each bar, an identifying icon 61A-64A is displayed, which identifies the information contained in that bar. In the embodiment of Fig. 6, the "TV GUIDE" icon 61A in the first bar corresponds to program schedule information from TV Guide® magazine, the "NOW SHOWING" icon 62A in the second bar 62 corresponds to pay-per-view and premium service events, the "MSO Logo" icon 63A in the third bar 63 corresponds to Customer Service or local cable company information messages, and the circular icon 64A in the fourth bar 64 corresponds to other interactive services available to the user, or in the case of broadband networks, other venues, e.g., home shopping, banking or telephone use. As also shown in Figs. 6 and 6A, each bar also contains a textual description of its contents.

When the user first enters the MENU mode, the system defaults to selection of the program schedule bar. When a particular bar is selected, the textual description is removed and a plurality of icons or identifying windows are displayed adjacent the identifying icon. In Fig. 6, the program schedule bar 61 is selected. Using the up or down direction arrow key on the remote controller 40, the user selects a vertically adjacent bar. Figs.

15-17 show, respectively, selection of the Pay-Per-View bar 62, the Customer Service or Messages bar 63 and the Interactive TV services bar 64.

An alternative MAIN MENU screen 215 is shown in Fig. 38. Certain selection screens accessible from the menu shown in Fig. 38 are shown in Figs. 38A and 38B. It has three horizontally selectable bars: program schedule 205, Home Theater 206 and Customer Service 207. The MAIN MENU screen 215 also contains an additional "Locator" identifier, which is described below.

Once a particular bar in the MENU screen is selected, the user can select a particular icon from the plurality of horizontally selectable displayed icons 65A-65C by using the left or right direction arrow and the ENTER key on the remote controller 40. Each icon contains a graphical symbol appearing in a background window of a particular color. When a particular icon is selected, it is offset from its background window and the color of the window changes. In Fig. 6, the grid icon 65A immediately adjacent the "TV GUIDE" icon in the first bar 61 is selected.

The function corresponding to the selectable entries in the MAIN MENU screen will now be discussed with reference to Fig. 6. It will be appreciated by those of skill in the art that the same functionality applies in the categories shown in the MAIN MENU 215 shown in Fig. 38.

In the uppermost vertically selectable horizontal bar 61, the first grid icon 65A represents an "All Listings" mode in which the program schedule information is displayed in a grid listing, such as that shown in Fig. 18. Alternatively, a single column grid-like display could be used, as that shown in Fig. 25. In this format, the vertical y-axis identifies the channel number and service while the horizontal x-axis identifies the time. The screen display of Fig. 18 also contains in the upper left-hand corner a mode identifier 180, in this case the notation "All Listings," to remind the user of the current operating mode of the system. Directly underneath the mode display is a highlighted display 181 of the channel that the user was watching before

entering the MENU mode. In the upper right-hand corner, a logo icon 182 appears in a window directly above a date/time identifier 183, which alternatively displays the current date and time.

In the center of the screen display shown in Fig. 18 is a graphical Active Key Display (AKD) 184 which indicates to the user those keys on the remote controller that are active for that particular mode of the program guide display system. For example, in the screen display of Fig. 18, the cursor can only move up, down or to the right. If the user were to depress the left direction arrow key on the remote controller at that point, the system would not carry out any function since the cursor can not move to the left. Thus, the left arrow key is not active so its image is not displayed on the AKD 184. Similarly, since the system will only respond to a depression of the up, down or right direction arrow keys and the ENTER key, they are the only key images displayed on the graphical AKD 184. The MODE key, though not displayed, is always active to change from one mode to another. When the user first enters the All Listings guide, the time listing begins by default at the half-hour immediately preceding the current time unless the current time is on the hour or half-hour, in which case the display begins with the particular hour or half-hour, and the channel listing begins at the last channel being viewed by the user before entering the MENU mode. For example, in Fig. 18, the current time is displayed as 7:13 p.m., the time listing begins at 7:00 p.m. and the channel listing begins with channel 4.

In the All Listings mode, a moveable highlighted cursor 185 is used to indicate the currently selected program to the user. The user manipulates cursor movement using the direction arrow keys on the remote controller 40. Furthermore, the entire information display pages upward if the cursor is placed at the bottom of the screen and the down direction arrow is depressed, and similarly pages to the left if the cursor is at the extreme right side of the display and the right direction arrow is

depressed. In this way, the user can navigate through the entire program schedule.

The folder icon 65B immediately to the right of the All Listings icon in the top horizontal bar 61 of Fig. 6 identifies a "Category Listing" mode in which program schedule information is displayed and categorized by program content, as shown in Fig. 19. The particular listing shown in Fig. 19 includes the categories of Movies, Sports, News and Children 190A-190D. The database record stored for each listing contains a content-specific identifier so the microcontroller can search the database and categorize the information by content for purposes of displaying it in the Category Listing mode. As shown in Fig. 19, the user can manipulate the cursor left or right to highlight any one of the categories which appear at the head of the listing. In Fig. 19, the "Movies" category 190A is selected. As shown, the user is given a display of all movies, prioritized by time and then alphabetically by title of show, beginning with the half-hour immediately preceding the current time unless the current time is on the hour or half-hour, in which case the display begins with the particular hour or half-hour. The screen display shown in Fig. 19 also includes a textual description of the current operating mode of the program schedule system, as well as the graphic AKD 184, similar to that used in connection with the All Listings mode.

As with the All Listings mode, if the user highlights a show which is currently airing, he can immediately tune to that show by depressing the ENTER key on the remote controller 40. If the highlighted show is one that will appear at future time, the user is again given the option of setting a REMINDER message.

The triangular icon 65C at the far right of the TV GUIDE bar 61 in the display of Fig. 6 identifies a "Channel Listing" mode in which the program schedule information is categorized and displayed by channel, as shown in Fig. 20. The screen display shown in Fig. 20 again includes a textual mode identifier 201, the graphic AKD 184, and the window including the logo icon 182 and

alternating time/date display 183. At the head of the program listing is a list of several consecutive channels 202A-202C beginning with the last channel viewed by the user before entering the Channel Listing mode. The channel in the middle window 202B 5 is highlighted and is the channel for which schedule information is displayed. The display identifies those programs appearing on the highlighted channel beginning with the half-hour immediately preceding the current time unless the current time is on the hour or half-hour, in which case the display begins with the particular 10 hour or half-hour. The user can display further future listings by manipulating the cursor to the bottom of the screen and paging the display, as previously described. The user can also change the selected channel by manipulating the left or right direction arrow keys on the remote controller 40. When the user issues a 15 change-channel command in this manner, the next consecutive channel will be displayed in the highlighted window 202B in the channel string at the head of the display, and schedule information for the newly selected channel will be displayed on the television receiver 27.

20 As with other modes, if a user wishes to tune to a highlighted program that is currently airing, he can do so by simply depressing the ENTER key on the remote controller 40, and if the user wishes to view a program that airs at a future time, the user is again given the option of setting a REMINDER message.

25 In each of the FLIP, BROWSE and MENU modes, a lower case "i" icon appears at a number of occasions in connection with certain program listings, such as movies, such as the "i" 203 shown in Fig. 20. Any time this icon appears, the user can view additional programming information, generally comprising a textual 30 description of program content and/or other information related to the program, such as the names of cast members and the like, by depressing the "i" key 48 on the remote controller 40. An example of a display of such additional information is shown in Fig. 21.

The second horizontal bar 62 appearing on the screen in 35 the MAIN MENU mode shown in Fig. 6 is the "Home Theater" Listing.

It corresponds to Pay-Per-View events or services, specialized programming, and Premium Service programs. When this category is chosen by the user, the television receiver displays information as shown in Fig. 15. The first theater-ticket icon 150 that appears in this Home Theater bar identifies a format in which the Pay-Per-View events and premium services are displayed, as shown in Fig. 22. As with other modes, the user can manipulate the cursor to highlight and select any particular show. Also, the user can obtain additional information about the Pay-Per-View event or service by depressing the "i" key 48 on the remote controller 40. The Pay-Per-View menu screen display shown in Fig. 22 also includes a video display section 220 in which short promotional clips of current and future events and services can be shown to the user while the user is viewing the Pay-Per-View scheduling information. The display of Fig. 22 is bit mapped such that the advertising clips may be shown in the lower left quadrant of the screen. The clips may be shown randomly in the video display section 120 or, alternatively, the clip shown could correspond to the particular selected entry on the list of events, and would change automatically as the user navigated through the list.

When a user highlights a Pay-Per-View event or service by manipulating the cursor to the desired event or service using the direction arrow keys on the remote controller 40, he can order the event or service by depressing the ENTER button on the remote controller, thus linking schedule, promotional and ordering functions. If the user selects a particular Pay-Per-View event or service in this manner, the programming schedule system will next present to the user a Pay-Per-View ordering screen such as that shown in Fig. 23. The display includes a figure representing the cost of the event or service. The display also asks the user to choose from among a plurality of scheduled airing times 230A-230C, as well as whether the user would like to see a REMINDER message prior to the start of the Pay-Per-View event or service. The user responds to these inquiries by using the direction keys on the

remote controller 40 to manipulate the cursor to the proper response and then depressing the ENTER key. After the user has ordered a Pay-Per-View event or service, the program schedule system will present the user with two ordering confirmation 5 submenus, such as shown in Figs. 24 and 24A. In either of these submenus, the user can confirm or cancel the Pay-Per-View event or service.

If the user confirms the order, the microcontroller 16 stores the Pay-Per-View ordering information in a location in 10 memory. The ordering information can then be transmitted to the cable operator by the microcontroller 16 either by phone line or on the cable line where the system has two-way communication or other such interactive capability. Alternatively, a computer at the cable operator location can interrogate the memory where the 15 microcontroller stored the Pay-Per-View ordering information. At the appropriate time, the cable operator supplies the Pay-Per-View event or service and it is received by all users who have ordered the program.

The second icon 151 in the Pay-Per-View bar of Fig. 15 20 identifies a specialized broadcast, cable or satellite programming service to which the user has access via the electronic program guide. In this mode, the electronic program guide application software acts to connect the user, through an appropriate data transmission link, to the programming service, at which point the 25 user interacts with the service. Alternatively, the electronic program guide provides the navigation software, including the menus and scheduling information, for the particular programming service. Such a service could be, for example, Your Choice TV ("YCTV"), a service offering reruns of highly rated broadcast and 30 cable programs, in which case the icon may take a form suitable to identify YCTV. The programming available on YCTV is then supplied to the user via the programming guide system.

The last icon 152 appearing in the Pay-Per-View bar of Fig. 15 identifies a display format which lists all Premium 35 Services offered by the cable operator, as shown in Fig. 26. In

this mode, the user can select for impulse ordering any one of the premium services by manipulating the cursor using the direction arrow keys on the remote controller and depressing the ENTER key. Similar to Pay-Per-View ordering, the system will present the user 5 with a series of ordering displays and, if a service is ordered by the user, it will confirm the user's request using another other submenu. If confirmed, the microcontroller 16 will store the ordering information or transmit it directly to the cable operator. Once the order has been confirmed, the microcontroller 10 can immediately allow the user access to the ordered premium service. In this manner, the user can order premium events or services on demand.

If, during FLIP or BROWSE modes, a user views a channel or schedule information for a service not subscribed to by the 15 user, the microcontroller 16 causes an ordering submenu to appear instead of displaying a program signal along with the graphic overlay, as shown in Fig. 9. This submenu indicates to the user that she does not currently subscribe to the selected service, and then asks the user if she would like to order the service. If the 20 user responds affirmatively, the program schedule system takes the user to the ordering submenu discussed above. In this manner, the user can order premium events or services on impulse.

The third horizontal bar 63 in the MENU mode shown in Fig. 6 is the "Messages" or "Customer Service" listing. As shown 25 in Fig. 16, the first envelope icon 160 represents message information available from the cable operator. When the user selects the message icon, he is presented with a screen display of currently available messages, as shown in Fig. 27. The display shown in Fig. 27 includes cable system messages 270 and billing 30 information 271. If the user selects the cable system messages option 270, she is presented with a message pertaining to the local cable operator, such as that shown in Fig. 28. If the user selects the billing status option 271 shown in Fig. 27, she is presented with a display of current billing information, such as 35 that shown in Fig. 29. This information may include a history of

purchases charged to the user, current balance information, pending orders, and, an indication of available credit, which can be an authorized debit limit previously arranged with the cable or other operator. Thus, a user could specify only a certain pre-set
5 spending limit. Once the amount of charges from pay-per-view events reaches the limit, the microcontroller would not permit further ordering of events. An alternative messages menu is shown in Fig. 28A.

The next icon 161 in the Customer Service information
10 bar 63 of Fig. 16 identifies a "Viewer Preference" mode, which allows the user to create or revise a number of program schedule system operating parameters. Once selected, this display presents the user with several preference options concerning certain operating parameters of the program schedule system, as well as
15 the viewing of certain channels and/or certain content-specific programming, for example, those shown in Fig. 7.

The first option shown in Fig. 7 is the "Parental" option 70, which can also be expressed as a "Key Lock Access" option. Once this option is initially selected by the user, the
20 system displays a "Key Lock Access" submenu such as that shown in Fig. 30.

The Key Lock Access menu shown in Fig. 30 allows the user to control access to individual channels and programs or events by requiring the user to enter an access code "key,"
25 consisting of a user-specified four digit code in the specific embodiment discussed herein, before ordering or viewing these pre-selected channels, programs or events. The menu display shown in Fig. 30 shows a series of subject categories that are entries in the vertical y-axis selectable by the user. A particular
30 subject category is chosen by using the up or down direction arrow keys on the remote controller 40 to highlight the desired entry. Once the user selects a particular subject category, the left and right arrow keys are used to navigate within the chosen category.

The first subject entry shown in Fig. 30 is the
35 "Parental Guidance" category 301. Once the user selects this

category by manipulating the cursor to highlight the entry, the cursor can be then moved horizontally to an active window 302 which displays and selects one the five letter rating items in the category. The letter items represent ratings of program content 5 as follows: "V" for violence, "N" for nudity, "L" for language, "AS" for adult situations and "PD" for parental discretion. Once the user selects a particular item, such as "L", by moving to the active window 302 using the right direction arrow key, depressing the ENTER key will indicate to the microcontroller 16 that a key 10 lock access has been selected for programs rated with a "L" rating for violent or explicit language. The system indicates activation of a key lock access by displaying a key icon directly below the "L" category display. Once a key lock access is set, it can be deactivated by selecting the category letter and then depressing 15 the ENTER key. This action causes the key icon to disappear. The user can change the rating category in the active window 302 by using the left or right direction arrow keys on the remote controller 40, images of which are displayed on the screen adjacent the active window as a reminder to the user. In this 20 manner, the user can select other rating categories for setting a key lock access for any of the program content identifiers appearing in the Parental Guidance category.

The key lock access code itself consists of a four digit code, which the user can enter and modify at any time. To do so, 25 the user highlights the fourth vertically selectable entry "Change Key Lock Access Code," 304 by manipulating the cursor to highlight it using the direction arrow keys on the remote controller. Once highlighted, the user enters a new four digit code or revises the then existing code and depresses the ENTER key. The 30 microcontroller 16 then identifies the new four digit key lock access code and stores it in memory. The user can clear the key lock access code, as well as all other previously activated keys, by moving to the last entry in Fig. 30, "Clear Key Lock Access Code and All Keys," 305 which highlights the "OK" window, and then

depressing the ENTER key. This action clears and deactivates all previously set keys, as well as the key lock access code.

The schedule information database record for each program contains a field that corresponds to the program content 5 identifiers in the Parental Guidance category. During operation, the microcontroller checks this field in response to a user command to tune to or order a program, or to display its corresponding schedule information before carrying out the tuning, ordering or displaying function. If the parental guide identifier 10 in the program schedule information database record matches any one of the activated parental guidance identifiers shown in Fig. 30, the user will be prompted to enter the four digit key lock access code before the system takes any further action. If the entered code matches the key lock access code previously entered 15 and stored by the user as described above, the system will carry out the user request to tune to the program, to order it, or to display its corresponding schedule information. If the code is not recognized by the system, no further action will be taken and the user's request will be denied.

20 By manipulating the cursor using the direction arrow keys to highlight the second entry, "MPAA ratings," 308 the user can also set a key lock access for programs based on their MPAA rating code, as also shown in Fig. 30.

As with the Parental Guidance category, once the MPAA 25 rating category has been selected, the user can move horizontally within the category to the active window 306 to select one the five rating codes, i.e., "G" for general audiences, "PG" for parental guidance, "PG-13" for suggested parental guidance, no one under 13 admitted without an adult, "R" for restricted and "X" for 30 x-rated. As with the Parental Guidance category, by selecting a particular rating --by using the left or right direction arrow keys until the particular rating code appears in the active window--and then depressing the ENTER key, the user sets a key lock access for the rating, in which case a key icon appears below 35 the rating code. And, as with the Parental Guidance category,

once a key lock access is set, the system will prompt the user to enter the four digit key lock access code anytime a request is made to tune to, order or display schedule information for a particular program having a rating code which matches a rating code for which key lock access has been activated.

The Key Lock Access mode also includes a subject category 303 for controlling access to channels, which may be entitled, for example, "Channel Block" or "Channel Lock." As with the Parental Guidance 301 and MPAA 308 categories, the user navigates to the Channel Block category 303 by manipulating the cursor using the direction arrow keys on the remote controller and depressing the ENTER key. Once the Channel Block category 303 has been entered, the user can move horizontally to an active window 307, which in Fig. 30 indicates channel 2. Once the user highlights this window by manipulating the cursor using the direction arrow keys on the remote controller 40, a key lock access can be set for the channel appearing in the active window. This is done, as with the other subject categories in the Key Lock Access mode, by depressing the ENTER key, which again causes a key icon to appear below the channel number in the active window. The user can move to the prior channel or to the next channel in sequence by depressing either the left or right direction arrow key on the remote controller 40. In this manner, the user can activate a key lock access for any available channel.

As with the Parental Guidance 301 and MPAA 308 categories, once a key lock access is set for a particular channel, the system will prompt the user to input the key lock access code prior to carrying out an instruction to tune to or order that channel. If the input key lock access code matches the previously stored access code, the user's instruction is carried out. Otherwise, the user's instruction is ignored. Thus, the user can control access to the audio and video program content of any available channel. In this instance, the microcontroller 16 will not allow audio or video program signals to pass to the VDG, but it will allow schedule information to appear for the channel.

An alternative method for effecting lockout of programs is accomplished using a "Lockout" screen, as shown in Fig. 39. In addition to limiting access to programs based on the Parental Guidance, MPAA and channel criteria, as discussed above, access 5 may be limited on the basis of program title. Fig. 39 shows an alternative Lockout screen 250 that can be used to permit or limit access to programs based on program title, in addition to the aforementioned criteria. Other parameters also may be included, such as time of day, day of week, credit limit, and content 10 category (e.g., talk shows).

To enter the Lockout screen 250 shown in Fig. 39, the user must enter a multi-digit lockout code using the numeric digit keys 42 and the enter key 44 on the remote controller 40. The lockout code is set initially when the system is first used or 15 installed. To set a lockout code in the first instance, the user accesses a Setup screen 260, such as that shown in Fig. 40. The Setup screen 260 will automatically appear the first time the electronic program guide is installed and initialized. For access during normal operation of the electronic program guide, a 20 suitable access path to the Setup screen 260 may be provided, such as from an appropriate icon in the MAIN MENU 215.

In the Setup screen 260 of Fig. 40, the user can navigate to the Lockout Code category 265 and set a new lockout code using the appropriate navigation and selection keys on the 25 remote controller 40. A suitable menu for inputting the lockout code is shown in Fig. 40A. Once enabled, the lockout code must be used to set or modify locks, to view a previously locked program, or to clear or change the lockout code. The memory location of the stored lockout code also should be remotely accessible, such 30 as by the local cable company, in case the user forgets the lockout code and it must be erased.

Once the lockout code is entered and the Lockout screen 250 of Fig. 39 is displayed, navigation within the screen is controlled by the direction keys 43A and 43B on the remote 35 controller 40. Using the up and down direction keys 43A to move

the selection cursor, either the Movie Rating 251, Parental Guidance 252, Channel 253, Locked Program 254 or Lockout Code 255 category can be selected. The left and right direction keys 43B are then used to navigate inside the selected category.

5 Clearing a previously set lockout code is accomplished by moving the selection cursor to the "Clear" entry 256 in the Lockout Code category 255 and depressing the enter key 44 on the remote controller 40. This causes the microcontroller to clear the lockout code stored in memory, as well as all locks previously
10 set by the user. To change the current lockout code, the user navigates to the "Change" entry 257 in the Lockout Code category 255 and depresses the enter key 44 on the remote controller 40. The user is then prompted to enter a new lockout code, which is subsequently stored in memory by the microcontroller.

15 To set a lock in either the Movie Rating 251 or Parental Guidance 252 category, the user navigates to the selected entry in Fig. 39 by manipulating the selection cursor using the direction keys 43A and 43B on the remote controller 40, and then depresses a lockout key on the remote controller, such as the padlock key
20 45A shown in Fig. 4. The microcontroller will appropriately modify the display to indicate that a lock has been set, for example, by changing the color of the text or the background in the selected entry window, or by displaying an appropriate icon next to the text in the selected entry window. In Fig. 39, a
25 padlock icon 258 appears in the window of the "PG" entry in the Movie Rating category 251. Toggling the lockout key while the selection cursor is positioned on a selected entry will alternately enable and disable the lockout function for that entry.

30 Similarly, to set a lock for a particular channel, the user selects the channel using the selection cursor and then depresses the lockout key. In Fig. 39, the channel "4 KCNC" entry in the Channel category 253 has been locked, which is indicated by the inverse video and padlock icon appearing in the window.

Program locks also may be set by title, which can be effected in several ways. For example, when the above-described FLIP or BROWSE mode of the electronic program guide is enabled, thereby causing the title of a program to be displayed along with other program schedule information in a window superimposed on the actual program signal then being received, the user can limit access to the program corresponding to the displayed program information by depressing the lockout key 45A on the remote controller 40. The user also may limit access to the currently tuned program by depressing the lockout key 45A on the remote controller 40 while viewing the program, regardless whether the FLIP or BROWSE modes are enabled. In this instance, the microcontroller first removes the program signal from the display and then accesses the schedule information database record for the program then appearing and sets an appropriate flag to indicate the program has been locked. Also, when viewing program schedule information in the grid or category listings, as discussed above and shown, for example, in Figs. 18-20, the user also can tag a program for lockout by highlighting it with the selection cursor and then depressing the lockout key 45A on the remote controller 40.

In each of these instances, the microcontroller then stores the program title in a lockout title list stored in memory along with any other titles that previously have been locked out by the user. Individual items in the lockout title list are displayed in alphabetical order in the "Locked Program" window shown in Fig. 39, and the user may scroll through the list by positioning the selection cursor on the Locked Program window using the up and down direction keys 43A on the remote controller in Fig. 40 and then using the left and right direction keys 43B to scroll through the list one item at a time. In order to save memory space, alternatively, the microcontroller may be programmed to set a flag or otherwise mark the particular database record containing the program schedule information for the program that is to be locked out, and to thereafter access the database to

retrieve the title information when it is to be displayed, such as when the viewer is reviewing the lockout title list in the Locked Program window 259.

Once an individual title has been locked out, the microcontroller can be programmed optionally to display an appropriate lockout icon, such as a padlock, whenever program schedule information for the locked program is to be displayed, such as in the window overlay of the FLIP or BROWSE mode, or in the various grid and category displays available in the MAIN MENU displays. The system also may display an appropriate text message if someone tries to access the program signal of a previously-locked program. Of course, once a program is locked, in all instances the microcontroller prevents access to the actual program signal (including both the audio and video portions of the program signal) until an appropriate code is entered or the lockout is removed.

Several methods can be used to block programs at their time of airing. For example, in the case of the Movie Rating, Parental Guidance and Channel categories, the schedule information database record for each program is provided with a field that corresponds to the rating, program content identifier or channel appearing, respectively, in the Movie Rating 251, Parental Guidance 256 and Channel 253 category of the Lockout screen 250 shown in Fig. 39.

During operation, the microcontroller checks the appropriate field in the database record in response to a user command to tune to or order a program before carrying out the tuning or ordering function. Additionally, the lockout code also may be used to restrict access to program schedule information. In this instance, the microcontroller also would check the appropriate field in the schedule information database record before displaying schedule information for a program.

If the movie rating, parental guidance or channel identifier in the program schedule information database record matches any one of the locked-out entries indicated in the Lockout

screen 250, a Lockout Verify screen 300 is displayed in overlaying relationship with the video signal then being displayed on the television receiver, as shown in Fig. 41. The user will be prompted to enter the previously set lockout code before the system takes any further action. As an added security measure, asterisks will be displayed as the user enters the lockout code. If the entered code matches the lockout code previously entered and stored by the user as described above, the system will carry out the user request to tune to or order the program, or to display its corresponding schedule information. If the code is not recognized by the system, no further action will be taken and the user's request will be denied. In this case, the Lockout Verify screen 300 will remain displayed on the television receiver waiting for a correct code to be entered. If no action is taken by the user, the Lockout Verify screen 300 will be removed after a predetermined time-out period, such as one or two minutes.

Similarly, in the case of lockout by title, the microcontroller also could check the title field in the schedule information database record and compare it with the list of program titles for which the user previously set a lock. If, as described above, the microcontroller does not maintain a list of the actual titles of programs locked by title, a suitable identifier can be set in a field in the database record to indicate that a program has been locked by title when the user first sets the lock, and, thereafter, the microcontroller could check that field in response to a user request to tune to or order a program, or display schedule information.

An alternative method for effecting lockout involves the use of a portion of the real-time program signal being received by the television receiver. With this method, codes corresponding to a program's rating, parental guidance category, title or channel are inserted into and transmitted along with the program signal, such as in the vertical or horizontal blanking intervals, or on raster scan lines that are not visible on the television receiver. When the program signal is received, these codes are stripped from

the program signal and stored in memory. Methods and apparatus for the insertion transmission and reception of digital codes carried on a program signal are known in the art.

After the transmitted codes have been separated from the
5 program signal and stored in memory, the microcontroller can compare them with the lockout criteria set by the user in the Lockout screen and take appropriate action, as described above.

The Setup screen 260 shown in Fig. 40 also contains a Purchase Code category 270, which allows the user to set a numeric
10 purchase code that must be entered before any premium channels or pay-per-view programs can be ordered. The Setup screen 260 shown in Fig. 40 includes entries for setting a new purchase code and for clearing or changing a previously set password. Appropriate menus for setting, confirming, clearing or changing the purchase
15 code are shown in Figs. 40B through 40E. Once a user sets a purchase code, the microcontroller thereafter will display a Purchase Code Verify screen in response to a user request to tune to or order a premium services channel or pay-per-view program. The Purchase Code Verify screen works in a manner similar to the
20 Lockout Verify screen 300 in that the user is prompted to enter the previously set purchase code password before the microcontroller will tune to or order the requested program. If the correct purchase code is not entered, the microcontroller will take no further action and the Purchase Code Verify screen will
25 remain displayed waiting for input of the correct code. If no action is taken within a predetermined time-out period, the Purchase Code Verify screen will be removed.

The next option shown in Fig. 7 is the Channel Preference or "Favorite Channel" list option 71. By highlighting
30 this icon and depressing the ENTER key on the remote controller 40, the user is presented with a submenu on the screen such as that shown in Fig. 8.

In normal operation, the program guide system presents channels to the user in numerical order in response to an up or
35 down change-channel command issued by the user using one of the

direction arrow keys on the remote controller. The channel number presentation sequence includes all channels offered by the cable company in the order of which they are modulated onto the channel by the operator.

5 The program guide system also provides the capability of selecting from among several user-defined channel presentation sequences, which are activated using one of the three "check mark" icon keys 48A, 48B or 48C on the remote controller 40 shown in Fig. 4. Each of these keys represents a preferred particular list
10 of channels which a particular user selects and which the microcontroller stores in memory as a "Channel Preference" list, as discussed in detail below. To activate one of these preferred channel lists, the user depresses the corresponding check-mark icon key, in which case the microcontroller may display the chosen
15 icon on the screen in the graphic overlays and full screen displays to remind the user that a particular channel preference list is being used by the system. Once a preference list is activated, the system will limit the tuning of the television receiver and the display of schedule information only to those
20 channels that are designated in the activated viewer preference list.

To revise the content and/or sequential order of the channels in the Channel Preference list, the user enters the MENU mode of the programming guide system. To enter the MENU mode from
25 the FLIP mode, the user twice depresses the MODE key 38 when using the remote controller 31 of Fig. 3. To enter the MENU mode when using the alternative embodiment of the remote controller 40 of Fig. 4, the user simply depresses the MENU icon key 47B.

When first entered, the MENU mode has a screen display
30 such as shown in Fig. 6. To select the submenu for editing the Channel Preference list, the user first selects the third horizontal bar 63, which can be titled, for example, "Messages" or "Customer Service," by manipulating the cursor using the down direction arrow key, as shown in Fig. 7. The screen of Fig. 6A is
35 thereby displayed. The user then selects the second icon 161

appearing in that bar, indicated with a check mark, which corresponds to a "Viewer Preference" mode, by highlighting the icon using the direction arrow keys and again depressing the ENTER key. This action will cause the microcontroller 16 to display a
5 Viewer Preference submenu such as that shown in Fig. 7. By selecting the Channel Preference or "Favorite Channel" entry 71, the user enters the Channel Preference submenu, shown in Fig. 8. If the user has not already done so, he would then depress the particular check-mark icon key on the remote controller 40 of
10 Fig.4 to create or revise the particular channel preference list.

In the Channel Preference menu shown in Fig. 8, a list
80 of all channels available on the particular cable system is displayed on the left side of the television receiver screen, labeled "Choices" in Fig. 8, and the viewer's preferred list 81,
15 designated "Selected" in Fig. 8, is displayed on the right side. If a particular code, such as an END or "-1" symbol appears in the first (uppermost) position 82 of the viewer preference list 81, the system displays information for all channels in numerical order in all modes of operation. This is the default mode of the
20 system.

By selecting channels in sequence from the available list 80 and placing them in the desired order in the preference list 81, the user can select a subset of channels and/or rearrange the default sequence in response to a channel up or channel down
25 command from the user. This is accomplished by highlighting a channel in the available list 80 using the up and down direction arrow keys on the remote controller 40 and depressing the ENTER key 44, which stores the entry temporarily in a buffer.

The microcontroller 16 stores a list of all channels
30 previously entered in the viewer preference list 81. As a particular channel is highlighted by the user when navigating through the available channel list 80 displayed on the left side of the television screen, a window 84 appears adjacent to the particular channel highlighted by the user. If the particular
35 channel already appears in the viewer preference list 81, the

system displays a "DELETE" message in the window 84 as a reminder that the channel was previously selected from the available channel list 80 and can only be deleted from the list 81, which is accomplished by depressing the ENTER key 44. If the particular highlighted channel in the list 80 was not previously selected, the system displays a "SELECT" message in the window 84 as a reminder that the particular channel will be selected for addition to the viewer preference list 81 if the user depresses the ENTER key 44. The microcontroller 16 inserts a selected channel at the bottom of the list 81. In this manner, the user can select or delete channels from the viewer preference list in any desired order.

The available channel list 80 may also be provided with categorical entries 83, such as movies, news, sports or children's shows. The user may also highlight any of these entries and put them into the viewer preference list 81. If the user does include a category in his viewer preference list 81, when the user issues channel up or down commands, the system will display, in sequence, first the user's selected preferred channels in numerical order and then all channels having a program whose content corresponds to the selected category or categories at the time.

Once the user has revised the channel preference list 81 in the described manner, the microcontroller 16 will follow the stored user-specified channel sequence in response to a change-channel command made by the user employing one of the direction arrow keys. To activate the viewer preference list, the user depresses one of the three check-mark icon keys 48A, 48B or 48C on the top of the remote controller shown in Fig. 4. The viewer preference list can be used to selectively limit tuning of the television receiver or display of schedule information in any of the operating modes of the electronic program guide. In the present embodiment, once a preference list is activated, the system will limit the tuning of the television receiver and the display of schedule information in the FLIP, and BROWSE modes, as well as in the grid category and channel listings in the MENU

mode, only to those channels designated in the activated viewer preference list. The tuner can not be tuned to, and no corresponding schedule information can be displayed for, any channel not entered in the viewer preference list when it is 5 activated. In this regard, it should be noted that setting a key lock access in the Parental Guidance 301, MPAA 308 or Channel Block 303 categories produces a different result than when using other display criteria, such as the Channel Preference List of preferred channels discussed above. Thus, while a key lock access 10 will prevent audio and video program information, but not schedule information, from being displayed or ordered absent entry of an authorization code, if a particular channel is included in the Channel Preference list and also has a key lock access activated in the Channel Block category 303 of the Key Lock Access mode, 15 that channel or its corresponding schedule information will not be displayed at any time.

To deactivate a previously selected viewer preference list, the user toggles the appropriate check-mark icon key on the remote controller 40 of Fig. 4. Once deactivated, the system 20 defaults to displaying and tuning all available channels, as well as displaying schedule information for all available channels.

Alternatively, the viewer preference list 81, if activated, can be used to control tuning and display of schedule information only in selected modes, such as only in the FLIP mode, 25 thus allowing the user to tune and view corresponding schedule information only for those channels entered in the preference list 81 in the FLIP mode, while viewing all channels and corresponding schedule information in all other modes.

In this latter configuration, as well as in the instance 30 where no channel preference list is activated and the system is in default mode, if a channel appears in the viewer preference list 81 that corresponds to a service not subscribed to by the user, the microcontroller 16 causes an ordering submenu to appear instead of displaying a program signal along with the graphic 35 overlay, as shown in Fig. 9. This submenu indicates to the user

that he does not currently subscribe to the selected service, and then asks the user if he would like to order the service. If the user responds affirmatively, the program schedule system takes the user to another ordering submenu to confirm the user's request, as
5 with impulse ordering.

The program guide also may be configured with a Locator screen 201, as shown in Fig. 37, which aids the viewer in channel selection and definition of a favorite channel list. The Locator screen 201 displays all available channel numbers grouped
10 according to the source of the program information appearing on any particular channel at any particular time, e.g., broadcast, cablecast, pay-per-view, near video on demand, satellite, or other source of program material. Thus, the Locator screen 101 can be used to locate any particular channel or service because the
15 groupings provide a quick and efficient method for scrolling through the list of available channels. The channel numbers also may be grouped according to other criteria, such as program category, program content, program rating or other content-based standard, time of availability, numerical order, or other logical
20 grouping.

In the example shown in Fig. 37, the user navigates within the Locator screen 201 using the direction keys 43A and 43B on the remote controller 40. The right and left direction keys 43B move the selection cursor within the category rows, while the
25 up and down direction keys 43A are used to select a particular category. From the Locator screen 201, any particular channel can be selected for viewing by positioning the selection cursor on the desired channel and depressing either the enter key 44 or an optional tune key (not shown) on the remote controller 40.

30 In addition to aiding in channel selection, the Locator screen 201 also provides the user with the ability to conveniently define favorite channel lists. To do so, the user first moves the selection cursor to the desired channel by using the direction keys 43A and 43B or numeric digit keys 42 on the remote controller
35 40, and then depresses a favorite channel key 46A provided on the

remote controller 40, which causes the display to change in some manner or characteristic as an indication that the channel has been selected as a favorite channel, such as by changing the color of the channel identification text or the text background, by displaying an appropriate icon or by some other appropriate identification scheme. In the remote controller 40 shown in Fig. 4, the pound key "#" can function as the favorite channel key.

Also, if multiple favorite channel lists are being used, the user would depress the appropriate favorite channel key on the remote controller to select a particular list before depressing the favorite channel key. For example, as discussed above, the remote controller 40 shown in Fig. 4, has three color-coded check-mark favorite channel keys 48A, 48B and 48C, which provide for at least three individual favorite channel lists for three individual users. Different identification characteristics could be displayed on the Locator screen 201 to indicate that a particular favorite channel list is selected. For example, the icon or image used to enable a favorite channel list on the remote controller, such as the check mark key 48A used on the remote controller 40 shown in Fig. 4, could be displayed on the Locator screen 201, as well as other screens of the program guide, when a favorite channel list is enabled. Alternatively, the color of the displayed text or background could be changed to match the color of the selected favorite channel key.

The Locator screen 201 may be accessed via several paths. For example, it may be included as a virtual channel that is conveniently positioned in the channel-tuning sequence, such as between the highest and lowest available channel numbers -- for example, a virtual channel 0. To the user, such a virtual channel appears to be a conventional channel. However, it requires no additional bandwidth as a carrier. For example, it can be digitally produced at the subscriber station or included in an appropriate blanking interval in existing bandwidth frequencies. In this manner, the virtual channel is accessible either by entering the corresponding channel number using the numeric digit

keys 42 on the remote controller, or by using the up and down direction keys 43A to wrap around from the highest to the lowest channel number, or vice versa. As shown in Fig. 38, it also may be desirable to provide a suitable identifier, such as an icon or
5 text message 210, in the MAIN MENU display 215, from which the user could access the Locator screen 201 simply by highlighting the identifier 210 with the selection cursor and depressing the enter key 44 on the remote controller 40. Alternatively, the remote controller may be provided with a key corresponding to the
10 Locator screen 201 which would cause the microcontroller to display the Locator screen 201 when the user depressed it.

In addition to Channel Preference or Favorite Channel keys, the remote controller 40 can also be supplied with a number of user-activated category preference icon keys, e.g., movies,
15 sports, or children's programming. The system can be adapted to present to the user only those programs meeting particular preference category when it is activated by the user. As with the Channel Preference icons, the microcontroller may display the icon corresponding to the activated preference category to remind the
20 user of the currently activated mode of system operation.

Additional preferences may be set from a screen 625 like that shown in Fig. 48, allowing the user to set parameters such as whether or not pop-up hints are displayed.

The question mark icon 162 at the far right of the third
25 horizontal bar in the menu of Fig. 16 identifies a program guide system "Help" mode in which information explaining the operation of the system is displayed for the user. Again, by manipulating the cursor using the appropriate keys on the remote controller, the user can select this mode. Once selected, the next submenu
30 appearing in the Help mode asks the user to identify the particular portion of the system about which the user would like to view Help information.

The icons appearing in the last horizontal bar of the MENU mode identify certain interactive and/or other types of
35 information services which the programming system, acting as a

gateway, makes available to the user as shown in Fig. 17. By manipulating the cursor, the user can select any one of the identified services, as shown in Figs. 31-35.

For example, if the user initially selects the "X*PRESS" icon appearing in the last horizontal bar, he is presented with a submenu such as that shown in Fig. 31. Using the direction arrow and enter keys on the remote controller, the user selects one of the three entries appearing in the display of Fig. 31. Once a particular entry is selected, the electronic program guide connects the user to the selected service and passes control to the particular service application software, as shown in Figs. 32-35.

Alternatively, the remote controller 40 can be supplied with a plurality of content-specific keys corresponding to a plurality of content-specific categories of programming, e.g., a Sports key, News key, Movie key, etc. When the user depresses a content-specific key, a content-specific mode is initiated. In Fig. 4, the remote controller is equipped with a Sports key 49. If the user depresses the Sports key 49, the microcontroller will limit the display of programs and/or program schedule information to those that are sports-related. The microcontroller will block all other programming or schedule information from appearing on the television receiver. The microcontroller can be adapted to distinguish programs and schedule information that are sports-related by examining an appropriate code associated with the program or schedule information.

As discussed above, coding can be accomplished using any number of methods, such as by including an appropriate code in the vertical blanking interval of the program signal, or in an appropriate memory location in the database record of the program schedule information, or if the schedule information is being received on a broadband network, by including it in an appropriate blanking interval. The user activates a content-specific mode by depressing the appropriate content-specific key in any mode of operation of the electronic programming guide, including the

aforescribed FLIP, BROWSE or MAIN MENU modes, as well as when no schedule information is being displayed and only a program signal is visible on the television receiver. Once a content-specific mode is requested by the user, the microcontroller immediately and
5 directly enables the content-specific programming criteria, and maintains it for all operating modes of the guide until disabled, which can be accomplished, for example, by toggling the Sports key 49.

Instead of a dedicated content-specific key, such as
10 Sports key 49, the system may be configured with a single, generic content-specific key, which, when activated, would cause the microcontroller to display a content-specific menu containing a list of all content-specific categories available to the user. The user then could highlight a particular category by
15 manipulating the selection cursor using the direction arrow keys on the remote controller and select it by depressing the ENTER or OK key 44. As an alternative to using a content-specific key on the remote controller, access to the content-specific menu can be effected by providing an appropriate identifier in another menu
20 screen of the electronic guide, such as in the LOCATOR, SETUP or MAIN MENU screens.

In addition to blocking all non-selected content-specific programming when a particular content-specific category has been selected, the microcontroller can be programmed to enable
25 all added-value programming or services that are specially related to the selected content-specific category. For example, if the user activates a Sports content-specific mode, the microcontroller, in addition to allowing only sports programming or schedule information related to sports programming to be
30 displayed, will proactively seek out and enable all sports related added-value services, such as related trivia or video games, up-to-date scores while a game is in progress, team schedules, replays of prior games of the selected teams or players, ticket or souvenir purchasing, etc. Thus, the information available from
35 the programming or service can be integrated into the environment

of the electronic program guide. Rather than simply passing control to another service as described above, in this manner the electronic program guide would function as a system integrator or interface to combine the available added-value information into a package within the electronic guide environment, thus essentially creating a series of modular electronic program applications corresponding to a variety of available content-specific categories.

The Setup screen shown in Fig. 40 also includes a Text Location category 275, which contains the textual entries "Bottom of Screen" and "Top of Screen." By navigating to the Text Location category 275 using the up and down direction keys 43A on the remote controller 40, and to either the "Top" or "Bottom" entries in that category using the left and right direction keys 43B on the remote controller, and then depressing the enter or select key 44, the user can control the position of the overlay windows used to display information in various operating modes of the electronic program guide. The Setup screen of Fig. 40 provides the user with two positional choices: the top or bottom of the screen. Depending on the modes of operation of the program guide, it may be desirable to provide the user with more positional choices in viewing area of the television receiver, or to provide the user with the ability to choose a different position for information displayed different operating modes.

One of the novel features of the disclosed invention is the textfit system. The preferred embodiment of the text fit system includes an interactive computer program used to edit the program listings data before it is transmitted to the user and stored in memory. The interactive system operates as follows: unedited (or partially edited) program listings information is loaded into data a processor. The data includes program titles, program schedule times, duration, category, as well as additional descriptive information dependent on the type of program. For example, for movies the data includes the MPAA rating, year of the

movie, whether it is in black and white, and a list of starring actors and actresses.

The data processor extracts only the program title data which includes television program titles as well as movie titles, 5 sporting events and titles for other special events. Based on the duration of the program, the data processor first analyzes the listings data to determine what grid size listings are needed for each title. Thus, a two hour movie could require four different edited titles to fit into each of the four different size grid 10 cells (30, 60, 90, 120 minutes). The data processor then determines how much space is required to display the title based on its character length. If the title is to be displayed in the program schedule grid using a proportional font and character to character kerning, the data processor may also account for these 15 factors in determining the space required to display a title. The determination would then be based on the number of pixels required for the particular combination of characters in the title. The amount of space available for display of a title depends on the size of the grid cell and the space required for display of icons, 20 when activated.

If the data processor determines that a full title requires too much space to fit into one or more grid cells, the title is then presented to the editor using a suitable display device connected to the data processor, such as a CRT. The editor 25 is then queried to alter the title so that it will fit in the allotted space. If the title must be edited for more than one cell size, the editor is queried to edit each of these separately. In the preferred embodiment of the interactive program, the editor is shown in real time whether the edited title will fit in the 30 designated grid cell.

In the preferred embodiment, two lines of text are displayed in each grid cell of the program listings. The title, as edited, appears on the first line, and if necessary, continues onto the second line. The decision to wrap-around to the second 35 line is based on whether natural breaks exist in the title such as

spaces between words, commas, periods, hyphens, etc. These are standard techniques used in word processing software routines. The editor may also be queried to edit a title in the situation where the full title will fit on the allotted two lines, but a 5 hyphen is required because there are no natural breaks in the title.

Prior to querying the editor to shorten a title, the data processor compares the title with a stored library of shortened titles to determine if the title had previously been 10 shortened while editing another listings database. Each time changes are made by the editor to a title, the shortened title is added to the library. It is apparent that this process of building a library of shortened titles greatly reduces the manual input required.

15 A flow chart illustrating the process by which the text fit system operates is shown in Fig. 42. The chart illustrates the operation of editing a listing for display in a program grid for a single platform, but operation is the same for all platforms.

20 Text editing may be necessary in other situations besides that where multiple size grid cells are used for display of the same title. For example, the disclosed program guide may run on several different platforms, with each one having different constraints and grid cell space availability. Some may not 25 display the text in proportional fonts and some may have other limitations reducing the available space. Thus, in the preferred embodiment the interactive program would request edits for all platforms for which they required at the same time. In addition, editing of text may be required for display modes other than a 30 grid of program listings. For example, in the "Listings by Channel" display of fig. 20, programs are listed on an entire, fixed-length line, but the length of the line may vary from platform to platform, so that the text fit system may be employed for the purpose of editing listings for the different platforms in 35 this display mode as well. The space available for the display of

text will also depend on how much space is reserved for icon display. The same process as that shown in fig. 42 would apply, except that there would be no need to determine what grid sizes are needed because a fixed length line is used for display rather than multiple sized grid cells.

It will be apparent to those of skill in the art that the disclosed text fit system has applications beyond that of title editing alone. The system may be easily modified to provide editing of messages, "i" screen storylines, pay-per-view promotional copy, and similar text messages so that they will fit into the designated space available for display of the text. In fact, the system may be used to edit any text for display in the disclosed program schedule system.

The computer program for the microcontroller 16 may also include a schedule for the display of varying background views upon which the program schedule information is overlaid either partially or in a full screen display. The background views may be stored as bit maps in memory or in another storage medium, such as an optical storage device. For example, the microcontroller 16 may be programmed to issue a command to the VDG every morning at 6:00 AM to display a sunrise in the background. The background may then be changed accordingly throughout the day to, for example, a blue sky or a nighttime view. It also may vary, e.g., by time of day, day of week, month, year or season. The mood background also could change depending on the particular category of programming that the user is watching or to which selected schedule information pertains. The mood background also may be adapted to display scenes that reflect the particular viewing area in which the user is situated, like the Rocky Mountains, or Mt. Rainier, etc. It also may be possible to display standard scenes, such as an ocean or forest scene. Moreover, the audio background also could be adjusted to relate to the particular mood background then being displayed. In addition, different background views may be used for holidays and special events, such as Christmas, Fourth of July, Superbowl Sunday, etc. The purpose of the background

views is to help ease the monotony of viewing program listings. The microcontroller 16 could be adapted automatically to coordinate the display of the mood background. The user also could be given the ability to choose from among various mood background displays by adapting the microcontroller to display an appropriate mood option menu that lists the mood background options available to the user and allows the user to select one or more by manipulating the selection cursor. Access to such a mood option menu could be achieved by supplying an appropriate identifier, textual or visual, in an appropriate menu of the system, such as the LOCATOR or SETUP screen.

In all of the operation modes, FLIP, BROWSE or MENU, the system may be configured to provide the user with context-sensitive "pop-up" hints. These hints appear either when the user explicitly asks for help or when the system detects that the user needs assistance through the user's inaction or key-stroke error, except in FLIP mode where the help would appear only if the user requests it or the user presses an improper key (*i.e.*, a key that does not correspond to a valid command at the current program guide operating point). As with the context-sensitive help described earlier, these hints could be text messages, instructional video images, and/or audio programs or messages. One novel feature of these "pop-up" hints is that they may be context sensitive, displaying information based on the user's current location within the guide and, possibly, taking into account the prior user control commands by which the user reached the current location.

For example, if the user enters the Listing By Time menu screen 400 displayed in Fig. 43A, which shows program listings for a single time period, and then either "stalls" (remaining inactive for more than a predetermined amount of time), requests help (possibly by pressing the "HELP" key 50), or presses an improper key, the system displays a hint 402 like that shown in Fig. 43A, instructing the user how to highlight another program. If the user takes no action in response, presses the "HELP" key 50, or

presses an improper key, the system displays a hint 412 like that in Fig. 43B, instructing the user how to watch the highlighted program. If the user continues to remain inactive, request help, or press improper keys, the system cycles through a number of 5 remaining hints like those shown in Figs. 43C through 43G, including a hint 422 showing how to retrieve program listings in a different time period, a hint 432 showing how to get more information on the highlighted program (if that information is available), a hint 442 showing how to restrict viewing of a 10 program, a hint 452 showing how to return to the previous screen, and a hint 462 showing how to watch television. In general, these hints have been chosen by expert users of the system to present the user with a hint related to the action that the expert user would most likely take, and subsequently hints in decreasing order 15 of likelihood that an expert user would perform the described action.

In a preferred embodiment, each hint is displayed one at a time. In an alternate embodiment, subsequent hints may be added to the hint or hints already displayed on the screen so that the 20 user is made aware of all the different available options at the same time.

If the user presses a valid key other than the "HELP" key 50 while displaying a hint, the system will remove the hint from the screen, and when the help system is next activated, it 25 will begin with the first hint in the list. In an alternate embodiment, if the user presses a command key while a hint is being displayed, the hint will be removed, but after a predetermined period of inactivity, the system will begin displaying hints, starting with the hint immediately following the 30 hint being displayed at the time the user presses the command key. This will allow the user to see the hints not already seen without requiring the user to wait while the system displays hints that have already been seen.

Where the user is viewing a different screen in the 35 program guide representative of a different operating point in the

program, e.g., the lock screen, the system displays hints appropriate to that screen. For example, as in Fig. 45A, when the user arrives at one embodiment of the lock screen 520, an appropriate hint 521 would be displayed. Fig. 45B shows a hint 5 526 that might be shown on the Change Timer screen 525, and Fig. 45C shows a hint 531 on the Listings by Title screen 530 to inform the user how to change letter 532 in a title being searched. This latter "Listings by Title" screen allows the user to select a program by entering the title alphabetically, using the up or down 10 arrow buttons 43A to change the currently highlighted letter and using the left and right arrow buttons 43B to highlight a different letter. This feature is described more fully in application serial no. 346,603, "Electronic Television Program Guide Schedule System and Method With Display and Search of 15 Program Listings By Title." Figs. 44A and 44B show screens 500 and 505 in the FLIP and BROWSE mode respectively displaying appropriate hints 501 and 506.

One way to implement these hints is to create a look-up table of all possible program guide operating points where a point 20 is defined by the current screen and the current highlight position. For example, one such point might be the point of having the third program title from the top 401 selected, as in Figs. 43A through 43G. For each point, the application program would contain a list of applicable hints structured so the first 25 hint is the most likely action that an expert user would take at that point, the second hint is the second-most likely action, and so forth. Methods for constructing such a list and storing it as part of an application program's code are well known in the art. As an example, for the point of having a program title 401 30 selected in the screen displayed in Figs. 43A through 43G, the

table would contain the following entries (in the indicated order):

| Entry Number | Hint |
|--------------|---------------------------------------------------|
| 5 1 | To highlight another program, press ▲ ▼ |
| 2 | To watch this program, press OK. |
| 3 | For next half-hour of listings, press ► |
| 4 | For more information on this program, press INFO. |
| 5 | To restrict viewing of this program, press LOCK. |
| 10 6 | To return to previous screen, press LAST. |
| 7 | To watch television press EXIT. |

Note that where the system is displaying program listings, as in Figs. 43A through 43G, the table of hints is likely to be the same or very similar for each program entry. In contrast, for screens such as the "Setup" screen 625 shown in Fig. 48, the tables for each of the entries are likely to be quite different. For example, the table of hints for the operating point of having the "Flip & Browse" entry 626 highlighted will contain hints relating to the various positions in which the FLIP and BROWSE mode windows may appear, while the table of hints for the point of having the "Flip Bar" entry 627 highlighted will contain entries relating to enabling and disabling the FLIP feature of the system.

The system may also take into account the present time in determining which hint to display. For example if the user is viewing a listing of shows starting at the present time 410, as shown in Fig. 43B, the hint 412 shown in that figure is appropriate, informing the user that the user may depress the "OK" button 44 to view the currently highlighted program. On the other hand, if the user is viewing a listing of a show that starts in the future, the hint 472, stating "To set a Reminder for this program, press OK." as shown in Fig. 43H would be shown.

Additionally, the system might take into account information stored in the program listings stored in memory in determining which hints to display. For example, if the highlighted program listing 431 does not contain additional information about a program, the hint 432 displayed in Fig. 43D would be inappropriate, and would be skipped.

In order to enable this context sensitivity, the table may contain predetermined conditions associated with each hint indicating for which contexts the hint is inappropriate. For example, one such condition may be that the hint should only be displayed if a program starting in the future is highlighted, so that hints 472 such as "To set a Reminder for this program, press OK." only appear when the highlighted program starts in the future. Another such condition might be that the hint should only be displayed if the current screen 480 is Listing By Time, and the currently highlighted program 481 is a pay-per-view program that has not been purchased yet, such as the hint 482 shown in Fig. 43I. As the system cycles through the hints, it checks each hint's conditions to see if the hint should be displayed. If the conditions indicate that the hint should not be displayed, the system skips that hint, and goes on to display the next appropriate hint. Fig. 46 shows a flow chart illustrating one version of this process using conditions.

As illustrated in Fig. 46, the pop-up hint feature is initiated, at 620, in response to either an explicit request to display a hint, an improper key-stroke, or a predetermined period of user inactivity, e.g. five seconds. The system, at 621, first checks the current screen 600. The system then uses the location of the highlight 605 to determine the current operating point of the system at 622. Next, at 623, the system checks for special conditions, for example, whether the highlight 605 is on a pay-per-view program, whether the highlight 605 is on a program that begins in the future, or whether the highlighted program has additional information associated with it. Next, at 624, the system fetches a table 615 of hints for the current operating

point from memory 610 (either read-only memory or RAM) and prepares the table 615 for operation (by, e.g., decompressing it if the table was compressed in memory). The following is an example of a table that might be used in the process illustrated 5 in Fig. 46:

| Entry No. | Hint | Conditions |
|-----------|----------------------------------------------------|----------------------------------------------------------------------------------------------------|
| 1 | To highlight another program, press ▲ ▼ | None. |
| 2 | To watch this program, press OK. | If program starts in future, or if program is pay-per-view and has not been purchased, don't show. |
| 10 3 | To set a reminder to watch this program, press OK. | If program is now showing or if program is pay-per-view and has not been purchased, don't show. |
| 4 | To purchase this program, press OK. | If program is not pay-per-view or has been purchased, don't show. |
| 5 | For next half-hour of listings, press ▶ | None. |
| 6 | For more information on this program, press INFO. | Don't show if additional information is not available. |
| 7 | To restrict viewing of this program, press LOCK. | Don't show if program is locked. |
| 15 8 | To allow viewing of this program, press LOCK. | Only show if program is locked. |
| 9 | To return to previous screen, press LAST. | None. |
| 10 | To watch television press EXIT. | None. |

After that, at 625, the system sets a counter to point to the first hint in the table 615. The system looks up the hint

and its associated conditions from the table 615, using the counter as an index into the table at 626. Next, at 627, the system compares the conditions to the previously checked context information to determine if the hint should be displayed. If, and only if, the hint is appropriate, the system displays the hint at 628. Next, at 629, the system determines whether the current hint is the last hint in the table of hints 615. If the current hint is not the last hint, the system increments the counter to point to the next hint in the table 615 at 630. Otherwise, the system sets the counter to point to the first hint at 625, to repeat the cycle. In this manner, the system cycles through all hints in the table, displaying them if appropriate. In an alternate embodiment, when the system reaches the last hint, the system will pause, displaying the last hint but not cycling through additional hints. In another alternate embodiment, when the system reaches the last hint, and the user remains inactive for a predetermined amount of time the hint will be removed from the screen and the pop-up hints feature will not reactivate until the user presses the "HELP" key 50 (at which time the system will display the first hint).

The microcontroller 16 generates commands to display these hints when either (1) the user presses the "HELP" key 50, (2) the user presses a key that does not correspond to a valid command at that point of operation of the application; or (3) the user remains inactive for a predetermined amount of time (e.g. five seconds). User inactivity may be ascertained by, e.g., using the system clock 19 to determine the amount of elapsed since the most recent received user control command. For example, if the user activates the guide but then takes no additional action for a period of five seconds, the first hint will be displayed. After the hint has been displayed, if the user presses the "HELP" key 50 again, presses an improper key, or remains inactive for another predetermined amount of time (which may be different from, and is preferably less than, the initial period), the system displays the next hint. The system, in this fashion, cycles through all

available hints. If the user presses a key representing a valid command other than "HELP," the system reverts to displaying the first hint for the particular state when the "pop-up" hint is next displayed. Alternatively, the system may be configured so that
5 the first hint is displayed automatically after a period of inactivity but second and subsequent hints are displayed only in response to a user command. In this alternate embodiment, in addition to displaying the initial hint, the system would also display a message to prompt the user to obtain a hint, e.g., "For
10 additional hints, press HELP." In this manner, rather than automatically cycling through a series of hints, if the user takes no action in response to the initial hint, the pop-up hint feature will deactivate after, e.g., ten seconds.

The system displays the hints by directing the VDG 23 to
15 overlay the help text over the currently active screen. The application program contains an algorithm to ensure that the displayed hint does not cover the cursor within the guide. Such algorithms are well known in the art. As previously indicated, the user may deactivate the pop-up hints feature.

20 In alternate implementations, the table of states might be expanded to include information about the previous command so the hints displayed could vary based on this information. Thus, a hint that is appropriate (because it provides information about a command that is available) may not be shown at first because the
25 user has demonstrated familiarity with the command by using it. For example, if the user enters the guide by depressing the MODE button 38, the alternate system might first display the hint
30 On the other hand, if the user arrives at the current state by pressing the up or down direction arrows 43A, (thus demonstrating that the user knows how to use those buttons) and then requests help, the alternate system would skip the earlier hint 402, and would first display the hint 412 shown in Fig. 43B, instructing

the user that the user may depress the OK button 44 to view the highlighted program.

One way to enable the system to take the previous action into account is to include the previous command in determining the operating point of the system. This technique would create a different table for each previous command so that, e.g., there would be one table for the point of having the third program title from the top selected in the Listing By Time screen with the MODE button 38 being the last key pressed, and another table for this configuration with the up or down direction arrows 43A being the last key pressed. Another way to implement this function is to add another condition to the appropriate entries in the table of hints. The condition would specify that the hint should be skipped on the first pass through the table of hints if the last command was some specified value. For example, for the hint "To highlight another program, press ▲ ▼", the table would contain a condition indicating that the hint should be skipped on the first pass if the last command was either the up or down direction arrow 43A. If the user presses the up or down arrow and then "stalls," when the system cycles through the appropriate hints, the system would skip this hint on the first pass, but would display it on all later passes. The following table illustrates how a table of hints could contain such a field (the other fields have been omitted for clarity):

| Entry No. | Hint | Skip if previous command was... |
|-----------|----------------------------------------------------|---------------------------------|
| 1 | To highlight another program, press ▲ ▼ | Up or Down Arrow |
| 2 | To watch this program, press OK. | |
| 3 | To set a reminder to watch this program, press OK. | |
| 4 | To purchase this program, press OK. | |
| 5 | For next half-hour of listings, press ► | Right Arrow |

| Entry No. | Hint | Skip if previous command was... |
|-----------|---------------------------------------------------|---------------------------------|
| 6 | For more information on this program, press INFO. | INFO |
| 7 | To restrict viewing of this program, press LOCK. | |
| 8 | To return to previous screen, press LAST. | LAST |
| 9 | To watch television press EXIT. | |

5 Fig. 47 illustrates how the system would use the table. In general, the system operates in the same manner as shown in Fig. 46, except that the system maintains a flag 620 indicating whether it is currently cycling through the list of hints for the first time. On each step through the table, the system checks to
10 see if it is on the first pass, it checks the table 615 to see if the current hint contains an entry in the "Skip if previous command was..." field, and it checks the previous command to see if it matches the entry in the "Skip if previous command was..." field. If all three of these conditions are true, the system
15 skips that hint and continues the cycle.

Audio hints may be implemented in a similar manner, the only difference being that the hints are played through the speakers of the television receiver rather than being displayed on the screen. As far as the content of the hints and control over
20 when they are presented, the same principles discussed above in connection with displayed hints would apply.

The pop-up hints concept of the present invention also has utility in, and may be readily extended to, many types of applications software programs run on a personal computer or other
25 type of data processor. For example, user help that appears on screen after a predetermined period of inactivity in a defined context may be used as follows. Existing hints on a computer running a graphical operating system appear only when the user moves the screen indicator over an on-screen control such as a

"button" or a menu entry. If the user is a novice to computers, it may not be readily apparent that the user may manipulate a mouse to move the on-screen indicator over on-screen controls. Using the present invention, the system may be configured to
5 display a message after a predetermined period of inactivity, informing the user of his or her options whether or not the screen indicator is over an on-screen control.

The pop-up hint concept of the present invention is particularly useful where the user begins a multi-step task by
10 executing a general command that places the application program into an intermediate state (e.g., by opening a dialog box), but then pauses, uncertain how to complete the task. Existing systems do not detect the user's inaction and do not prompt the user with help information to inform him of the various available options.
15 The current invention provides guidance to users who reach such intermediate points by providing pop-up hints that provide information on how to complete tasks from the intermediate point. For example, a user may wish to set the margins for a document, so the user chooses a menu option entitled "Format Document..." This
20 causes the program to open a dialog box 630, shown in Fig. 49, relating to overall document formatting. If the user then stalls at this intermediate point, the present invention may present pop-up a hint 631 that provides information such as: "To set the margins, click in the box next to the word 'Left' in the 'Margins'
25 box and type the desired value. Then, press OK." In this way, the system provides focused, task-oriented help in a manner that is not available in current systems.

Just as for an EPG, multiple hints may be ordered based on the likelihood of user selection. For example, if a user
30 stalls while displaying a "Print" dialog box in a word processing application, the series of hints displayed might be: "1. To print the document, enter 'D'; 2. To print the current page, enter 'P'; 3. To print a range of pages, enter the page range." The hints may be displayed serially or simultaneously.

Another application of the present invention in general purpose computer systems in that it provides a means to display multiple hints for a single control. In many computer operating systems, on-screen controls may perform different functions if the user holds down certain modifier keys (e.g., "Shift" or "Alt") while clicking on the control. Existing help systems do not inform the user of these alternative actions since they are limited to displaying a single hint for each control. If the present invention is implemented in such a system, it may display a single hint for each modifier key that alters the function of the on-screen control (e.g., "Click this button to print", "Hold down the Alt key while clicking this button to send the current document via E-mail", "Hold down the Shift key while clicking on this button to send the current document via fax"). These hints may be displayed serially in decreasing order of likelihood that a user would choose that option.

Additionally, the electronic program guide could be configured to store a unique digital identifier for each program along with its schedule information and later use the identifier - e.g., by transmitting it -- to indicate to a recording or storage device, such as a video recorder, that the user wishes to record the program. The program guide could also use the identifier to automatically control operation of the video recorder. The electronic program guide could also be configured to use other stored schedule information for this purpose.

The form and content of a particular computer program to implement the invention disclosed herein will be readily apparent to those skilled in the art of video system programming and graphic display. A flow chart showing the operation logic of the system is shown in Fig. 36. It will also be appreciated by those skilled in the art that there can be departure from the specific embodiment of the invention described herein without departing from the true scope of the claims appended hereto.

We claim:

1. An electronic television program guide system comprising:

5 means for receiving user control commands for controlling the operation of said guide;

timing means for determining the elapsed time since the most recent received user control command;

10 storage means for storing i) program schedule information for a plurality of television programs, and ii) a plurality of predetermined hints for operating said guide wherein each said hint is associated with at least one of said user control commands;

15 data processing means coupled to said receiving means and said storage means for generating i) a first video display control command in response to a first user control command to display a program guide information screen representative of a program guide operating point, and ii) a second video display control command to display a predetermined hint in partial
20 overlaying relationship with said information screen, said second video display command being generated when said elapsed time equals a first predetermined amount of time or in response to a second user control command that is not valid for said program guide operating
25 point; and

30 video display generator means coupled to said data processing means and said storage means for receiving said video display control commands from said data processing means, and generating a display signal comprising said predetermined hint in partial overlaying relationship with said information screen.

2. The system of claim 1 wherein said information screen comprises a portion of said program schedule information for a plurality of television programs.

3. The system of claim 1 wherein said information screen comprises a screen for setting parameters to control the operation of the guide.

4. The system of claim 1 wherein said data processing means comprises means for sequentially generating a plurality of second video display control commands to display a plurality of said hints in sequence in partial overlaying relationship with said information screen.

5. The system of claim 4 wherein said sequence is defined using a look-up table associated with said operating point of said program guide.

6. The system of claim 5 wherein said plurality of hints are arranged in said table in decreasing order of likelihood that the command or commands associated with said hint will be executed from said program operating point.

7. The system of claim 4 wherein said sequence is defined based upon a prior user control command.

8. The system of claim 5 wherein said sequence is further defined based upon a prior user control command.

9. The system of claim 4 wherein said timing means further determines the elapsed time since the most recent of said sequentially generated second video display control commands, and said data processing means generates the next sequential second video display control command is generated after said elapsed time since the most recent of said second sequentially generated video display control commands equals a second predetermined amount of time.

10. The system of claim 4 wherein each of said plurality of second video display control commands is generated in response to a received user control command.

11. The system of claim 1 additionally comprising a remote control device for generating said user control commands.

12. The system of claim 1 wherein said information screen comprises a cursor and said hint is displayed in partial

overlaying relationship with said information screen so as not to obscure the position of said cursor.

13. The system of claim 1 wherein said predetermined hint is selected by said data processing means based upon said program guide operating point.

14. The system of claim 13 wherein said predetermined hint is selected by said data processing means further based upon said most recent received user control command.

15. The system of claim 13 wherein said data processing means determines a set of valid user control commands in accordance with said program guide operating point and said predetermined hint is selected further based upon said set of valid user control commands.

16. The system of claim 13 wherein said data processing means determines the current time and said predetermined hint is selected further based upon said current time.

17. The system of claim 13 wherein said predetermined hint is selected by said data processing means further based upon information derived from said program schedule information.

18. An electronic television program guide system comprising:

means for receiving user control commands for controlling the operation of said guide;

storage means for storing i) program schedule information for a plurality of television programs, and ii) a plurality of predetermined hints for operating said guide wherein each said hint is associated with at least one of said user control commands;

data processing means coupled to said receiving means and said storage means for generating i) a first video display control command in response to a first user control command to display a program guide information screen representative of a program guide operating point, and ii) a second video display control command to display one of said predetermined hints in

partial overlaying relationship with said information screen, wherein said second video display command being generated in response to a second user control command that is not valid for said program guide operating point; and

video display generator means coupled to said data processing means and said storage means for receiving said video display control commands from said data processing means, and generating a display signal comprising said predetermined hint in partial overlaying relationship with said information screen.

19. The system of claim 18 wherein said data processing means comprises means for sequentially generating a plurality of second video display control commands to display a plurality of said hints in sequence in partial overlaying relationship with said information screen.

20. The system of claim 19 wherein said plurality of hints are arranged in said table in decreasing order of likelihood that the command or commands associated with said hint will be executed from said program operating point.

21. The system of claim 18 wherein said predetermined hint is selected by said data processing means based upon said program guide operating point.

22. An electronic television program guide system comprising:

means for receiving user control commands for controlling the operation of said guide;

timing means for determining the elapsed time since the most recent received user control command;

storage means for storing i) program schedule information for a plurality of television programs, and ii) a plurality of predetermined hints for operating said guide wherein each said hint is associated with at least one of said user control commands;

5 data processing means coupled to said receiving
means and said storage means for generating i) a first
video display control command in response to a first
user control command to display a program guide
information screen representative of a program guide
operating point, ii) a second video display control
command to display a first predetermined hint in
partial overlaying relationship with said information
screen in response to a second user control command,
10 and iii) a third video display control command to
display a second predetermined hint in partial
overlaying relationship with said information screen,
wherein said third video display control command is
generated when said elapsed time equals a first
15 predetermined amount of time, or in response to a third
user control command that is not valid for said program
guide operating point; and

video display generator means coupled to said data
processing means and said storage means for receiving
20 said video display control commands from said data
processing means and generating a display signal
comprising at least one of said predetermined hints in
partial overlaying relationship with said information
screen.

25 23. The system of claim 22 wherein said information
screen comprises a portion of said program schedule information
for a plurality of television programs.

24. The system of claim 22 wherein said data processing
means comprises means for sequentially generating a plurality of
30 second video display control commands to display a plurality of
said hints in sequence in partial overlaying relationship with
said information screen.

25. The system of claim 24 wherein said sequence is
defined using a look-up table associated with said operating point
35 of said program guide.

26. The system of claim 25 wherein said plurality of hints are arranged in said table in decreasing order of likelihood that the command or commands associated with said hint will be executed from said program operating point.

5 27. The system of claim 22 additionally comprising a remote control device for generating said user control commands.

28. The system of claim 22 wherein said information screen comprises a cursor and said hint is displayed in partial overlaying relationship with said information screen so as not to
10 obscure the position of said cursor.

29. The system of claim 22 wherein said predetermined hint is selected by said data processing means based upon said program guide operating point.

30. The system of claim 29 wherein said data processing
15 means determines the current time and said predetermined hint is selected further based upon said current time.

31. The system of claim 29 wherein said predetermined hint is selected by said data processing means further based upon information derived from said program schedule information.

20 32. An electronic television program guide system comprising:

means for receiving user control commands for controlling the operation of said guide;

25 timing means for determining the elapsed time since the most recent received user control command;

30 storage means for storing i) program schedule information for a plurality of television programs, and ii) a plurality of predetermined hints for operating said guide wherein each said hint is associated with at least one of said user control commands;

35 data processing means coupled to said receiving means and said storage means for generating i) a video display control command in response to a first user control command to display a program guide information screen representative of a program guide operating

point, and ii) a hint retrieval command to cause a hint to be retrieved from said storage means, wherein said hint retrieval command is generated when said elapsed time equals a first predetermined amount of time, or in response to a second user control command that is not valid for said program guide operating point;

means coupled to said data processing means and said storage means for receiving said video display control command from said data processing means, and generating a display signal comprising said information screen; and

means for presenting said retrieved hint in a form recognizable by said user while said information screen is being displayed.

33. A process for providing an electronic television program guide comprising:

receiving user control commands for controlling the operation of said guide;

determining the elapsed time since the most recent received user control command;

storing i) program schedule information for a plurality of television programs, and ii) a plurality of predetermined hints for operating said guide wherein each said hint is associated with at least one of said user control commands; and

displaying i) a program guide information screen representative of a program guide operating point in response to a first user control command, and ii) a predetermined hint in partial overlaying relationship with said information screen, said hint being displayed when said elapsed time equals a first predetermined amount of time or in response to a second user control command that is not valid for said program guide operating point.

34. The process of claim 33 additionally comprising sequentially displaying a plurality of said hints in partial overlaying relationship with said information screen.

35. The process of claim 34 wherein said sequence is defined using a look-up table associated with said operating point of said program guide.

36. The process of claim 35 wherein said hints are arranged in said table in decreasing order of likelihood that the command or commands associated with said hint will be executed from that program operating point.

37. The process of claim 34 wherein said sequence is defined based upon a prior user control command.

38. The process of claim 35 wherein said sequence is further defined based upon a prior user control command.

39. The process of claim 34 wherein each of said plurality of hints is displayed for a second predetermined amount of time.

40. The process of claim 34 wherein each of said plurality of hints is displayed in response to a second user control command.

41. The process of claim 33 wherein said user control commands are generated using a remote control device.

42. The process of claim 33 additionally comprising displaying a cursor on said information screen and displaying said hints in overlaying relationship with said information screen in such a position as not to obscure the position of said cursor.

43. The process of claim 33 wherein said predetermined hint is selected based upon said program guide operating point.

44. The process of claim 43 wherein said predetermined hint is selected further based upon said most recent received user control command.

45. The process of claim 43 additionally comprising determining a set of valid user control commands in accordance with said program guide operating point and selecting said

predetermined hint further based upon said set of valid user control commands.

46. The process of claim 43 further comprising determining the current time and selecting said predetermined hint 5 further based upon said current time.

47. The process of claim 43 further comprising selecting said predetermined hint further based upon information derived from said program schedule information.

48. A process for providing an electronic television 10 program guide comprising:

receiving user control commands for controlling the operation of said guide;

15 storing i) program schedule information for a plurality of television programs, and ii) a plurality of predetermined hints for operating said guide wherein each said hint is associated with at least one of said user control commands; and

20 displaying i) a program guide information screen representative of a program guide operating point in response to a first user control command, and ii) a predetermined hint in partial overlaying relationship with said information screen, wherein said predetermined hint is displayed in response to a second user control command that is not valid for said 25 programguide operating point.

49. The process of claim 48 additionally comprising sequentially displaying a plurality of said hints in partial overlaying relationship with said information screen.

30 50. The process of claim 49 wherein said plurality of hints are arranged in said table in decreasing order of likelihood that the command or commands associated with said hint will be executed from said program operating point.

35 51. The process of claim 48 wherein said predetermined hint is selected by said data processing means based upon said program guide operating point.

52. A process for providing an electronic television program guide comprising:

receiving user control commands for controlling the operation of said guide;

5 determining the elapsed time since the most recent received user control command;

10 storing i) program schedule information for a plurality of television programs, and ii) a plurality of predetermined hints for operating said guide wherein each said hint is associated with at least one of said user control commands; and

15 displaying i) a program guide information screen representative of a program guide operating point in response to a first user control command, and ii) a predetermined hint in partial overlaying relationship with said information screen in response to a second user control command, and iii) a second predetermined hint in partial overlaying relationship with said information screen, wherein said second predetermined
20 hint is displayed when said elapsed time equals a predetermined amount of time or in response to a third user control command that is not valid for said program guide operating point.

25 53. The process of claim 52 further comprising sequentially displaying a plurality of said hints in partial overlaying relationship with said information screen.

54. The process of claim 53 wherein said sequence is defined using a look-up table associated with said program guide operating point.

30 55. The process of claim 54 wherein said plurality of hints are arranged in said table in decreasing order of likelihood that the command or commands associated with said hint will be executed from said program operating point.

56. The process of claim 52 additionally comprising generating said user control commands by means of a remote control device.

57. The process of claim 52 further comprising
5 displaying a cursor and displaying said hint in partial overlaying relationship with said information screen so as not to obscure the position of said cursor.

58. The process of claim 52 wherein said predetermined hint is selected based upon said program guide operating point.

10 59. The process of claim 58 further comprising determining the current time and selecting said predetermined hint further based upon said current time.

60. The process of claim 58 wherein said predetermined hint is selected further based upon information derived from said
15 program schedule information.

61. A process for providing an electronic television program guide comprising:

receiving user control commands for controlling the operation of said guide;

20 determining the elapsed time since the most recent received user control command;

storing i) program schedule information for a plurality of television programs, and ii) a plurality of predetermined hints for operating said guide wherein
25 each said hint is associated with at least one of said user control commands;

displaying a program guide information screen representative of a program guide operating point in response to a first user control command;

30 retrieving a hint from said storage means; and presenting said retrieved hint in a form recognizable by said user when said elapsed time equals a predetermined amount of time.

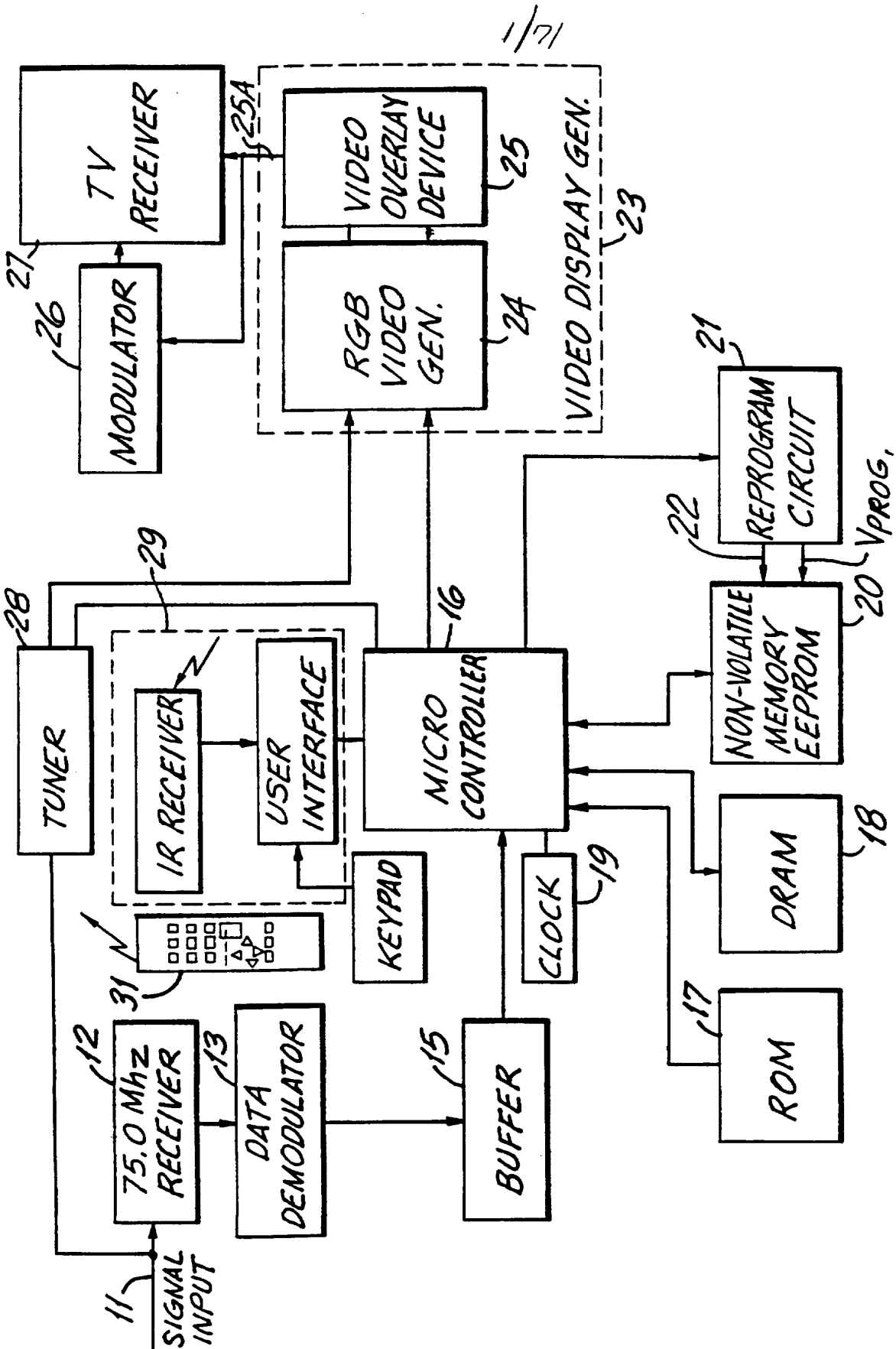

FIG. 1

2/71

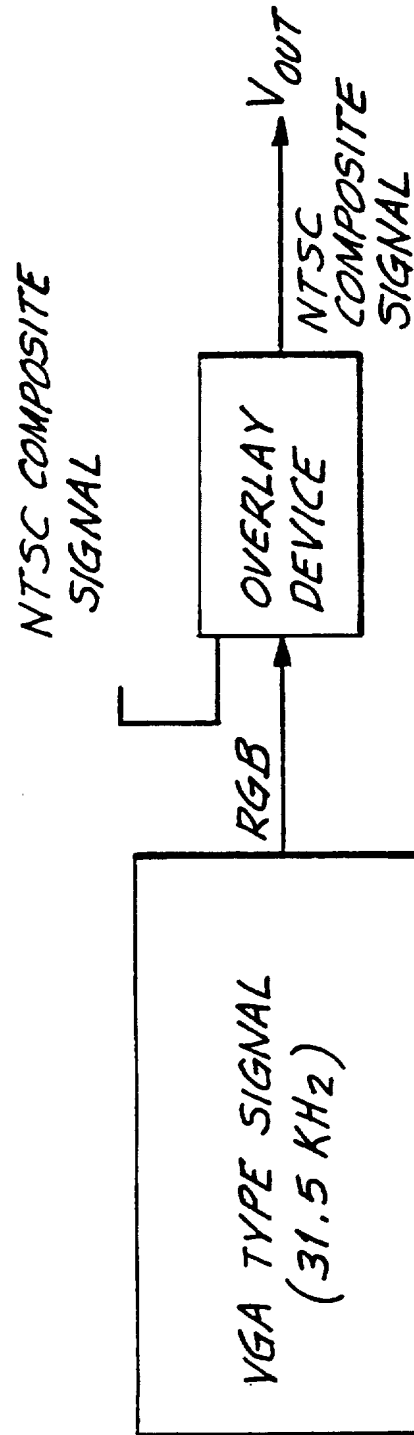

FIG. 2

3/71

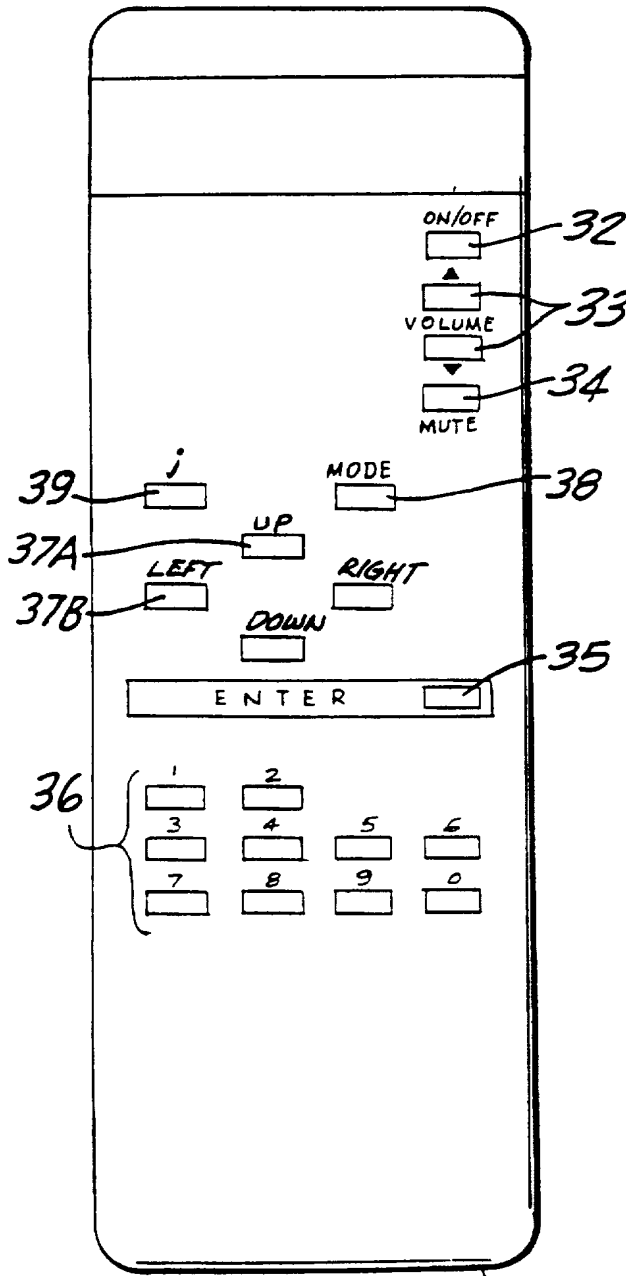

FIG. 3

31

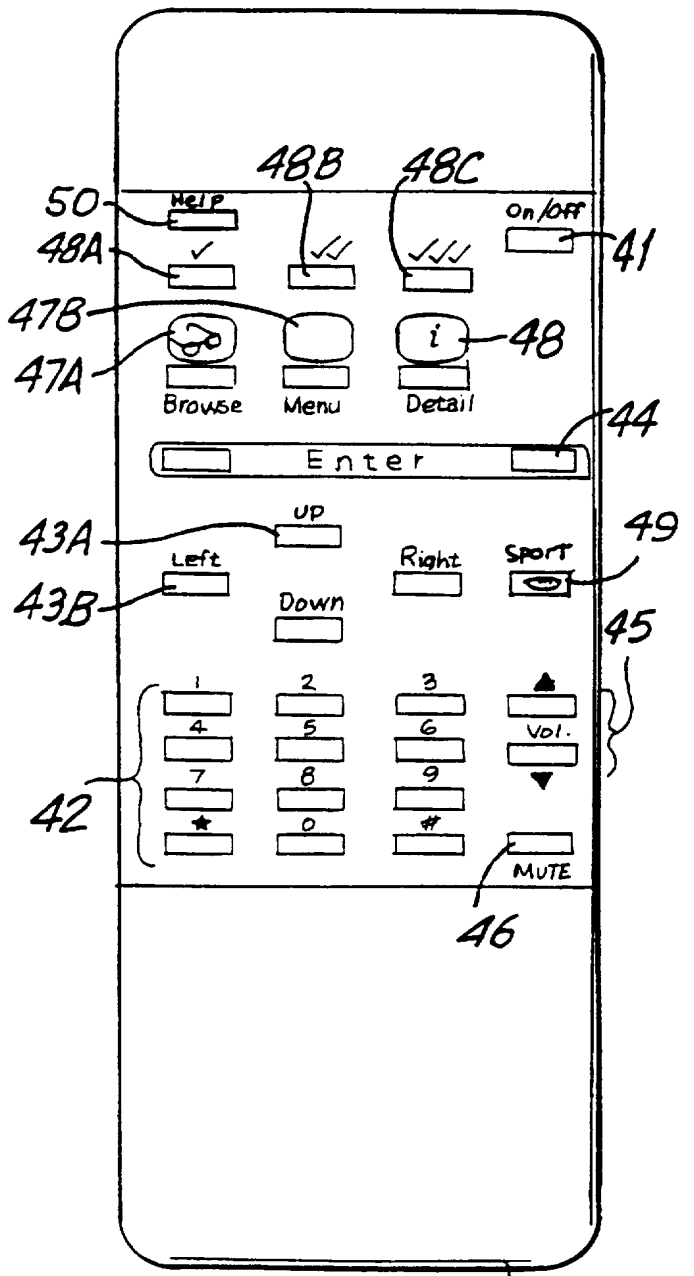

FIG. 4

40

4/71

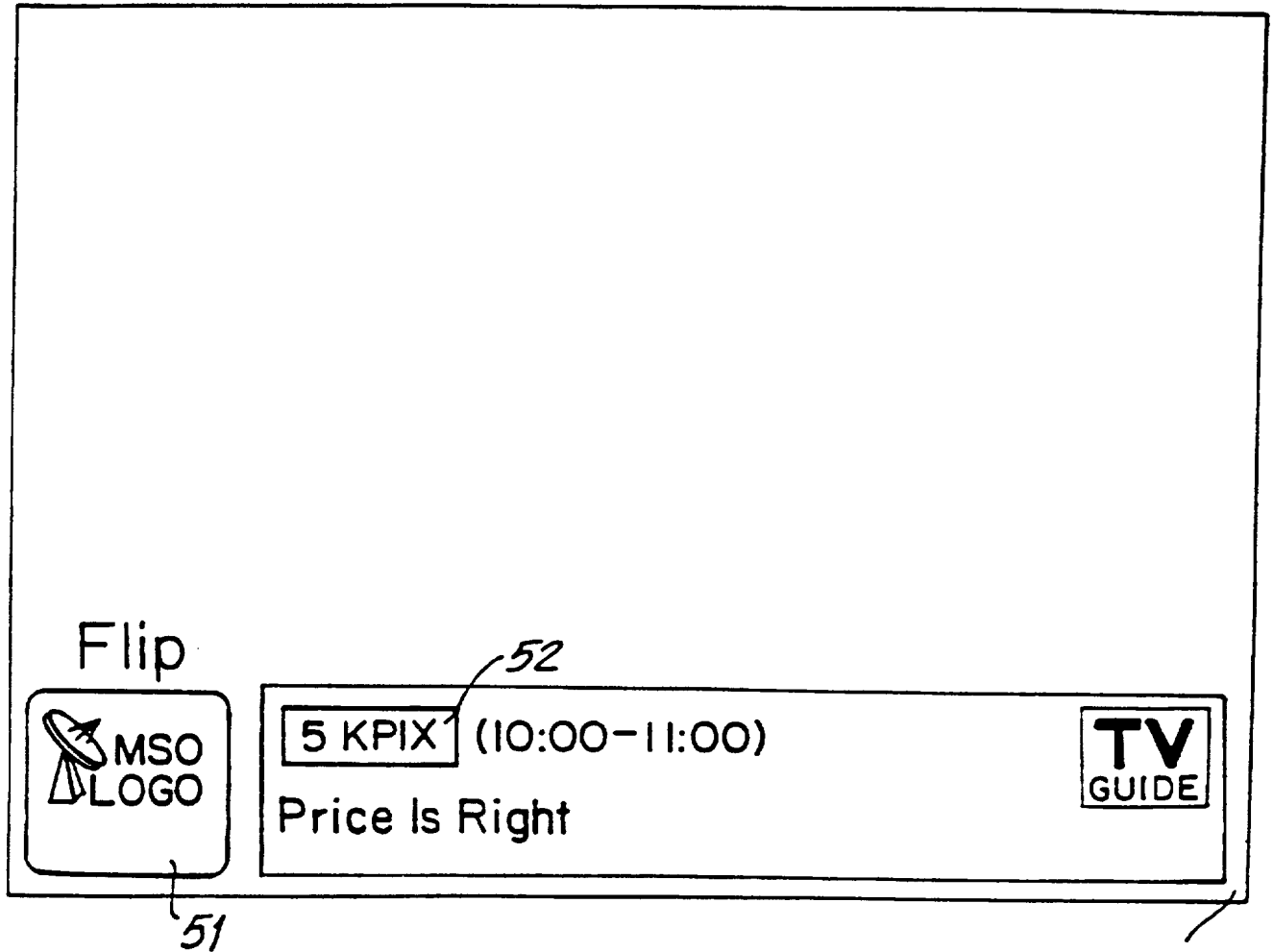
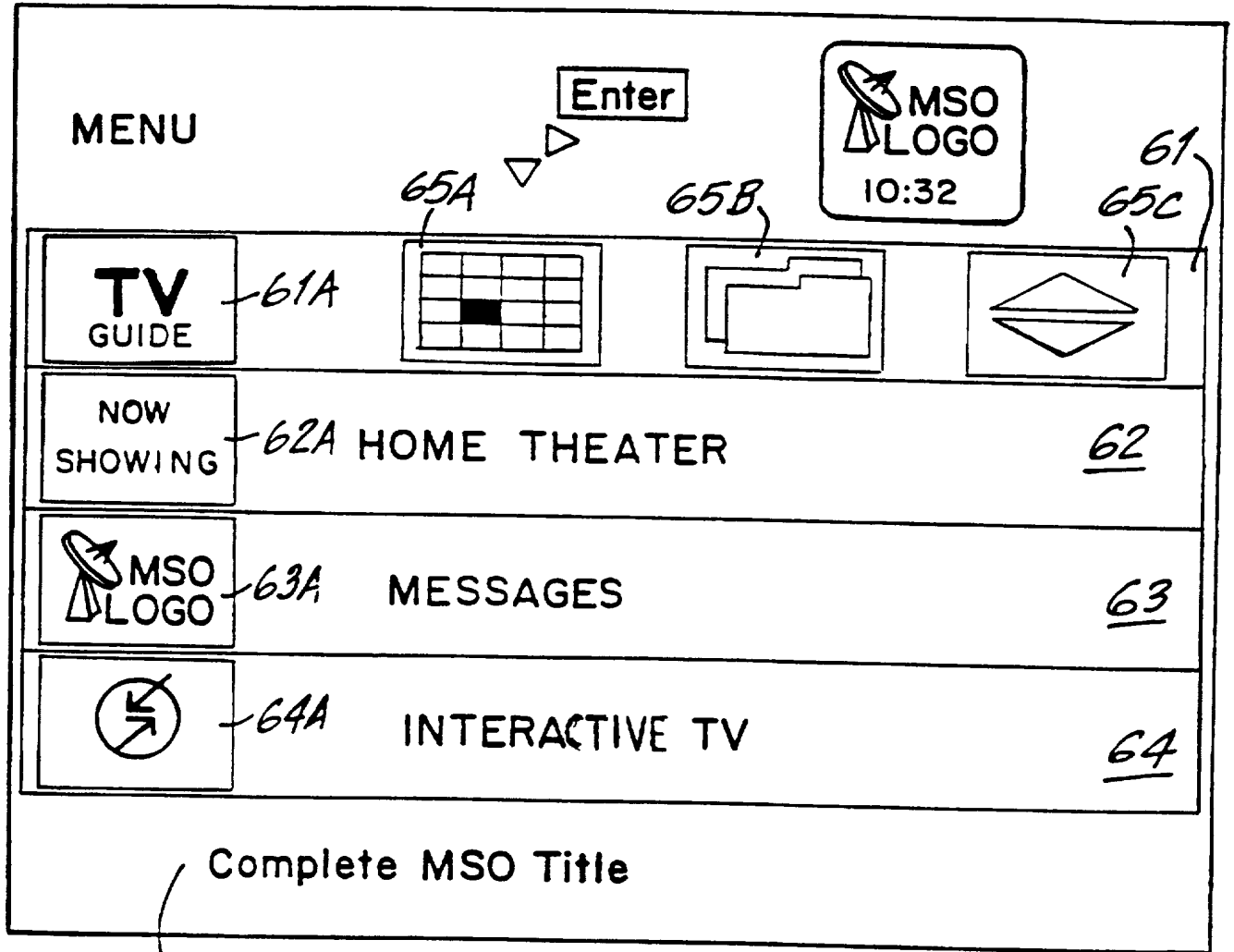

FIG.5

5/71



65

FIG.6

6/71

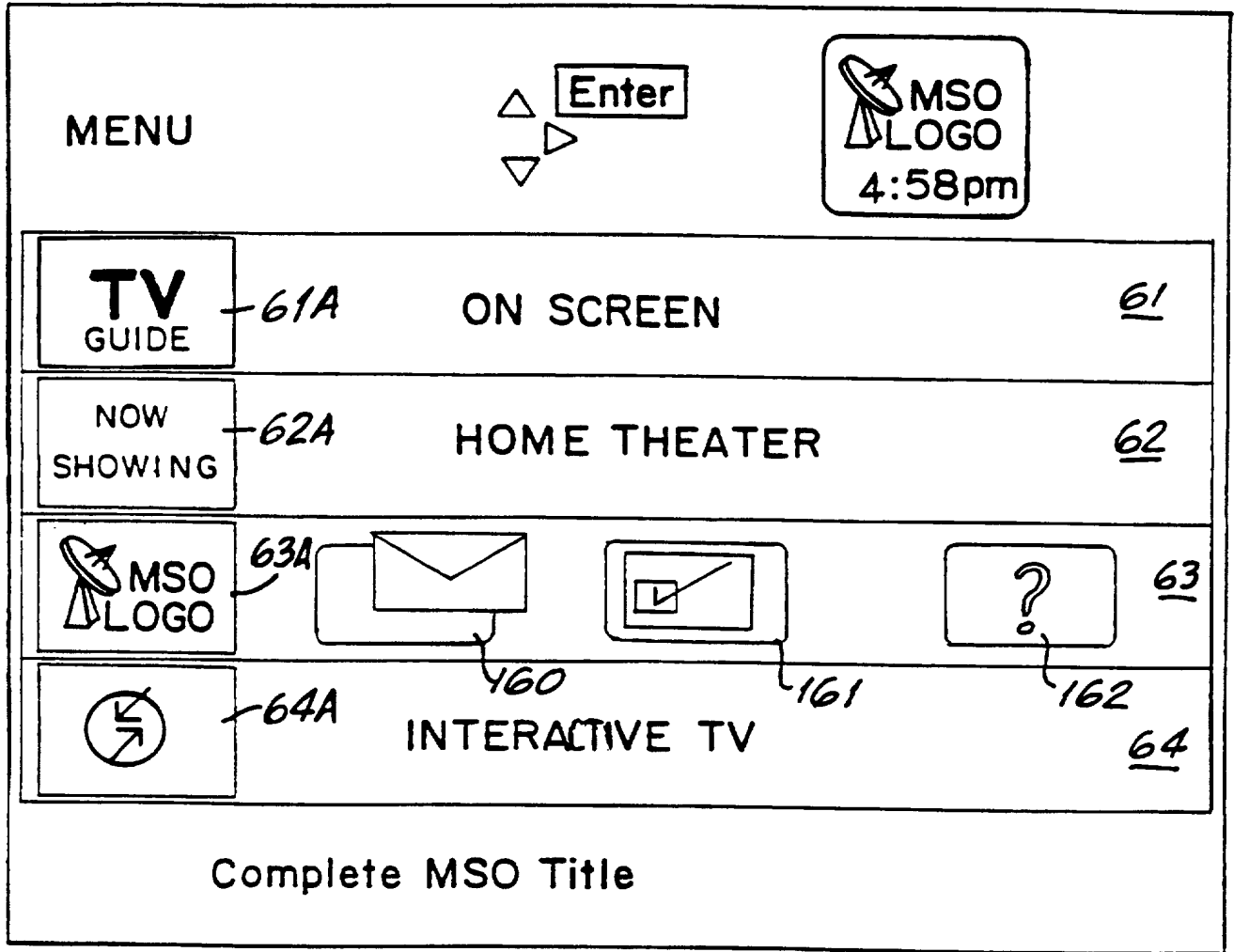

FIG.6A

7/71

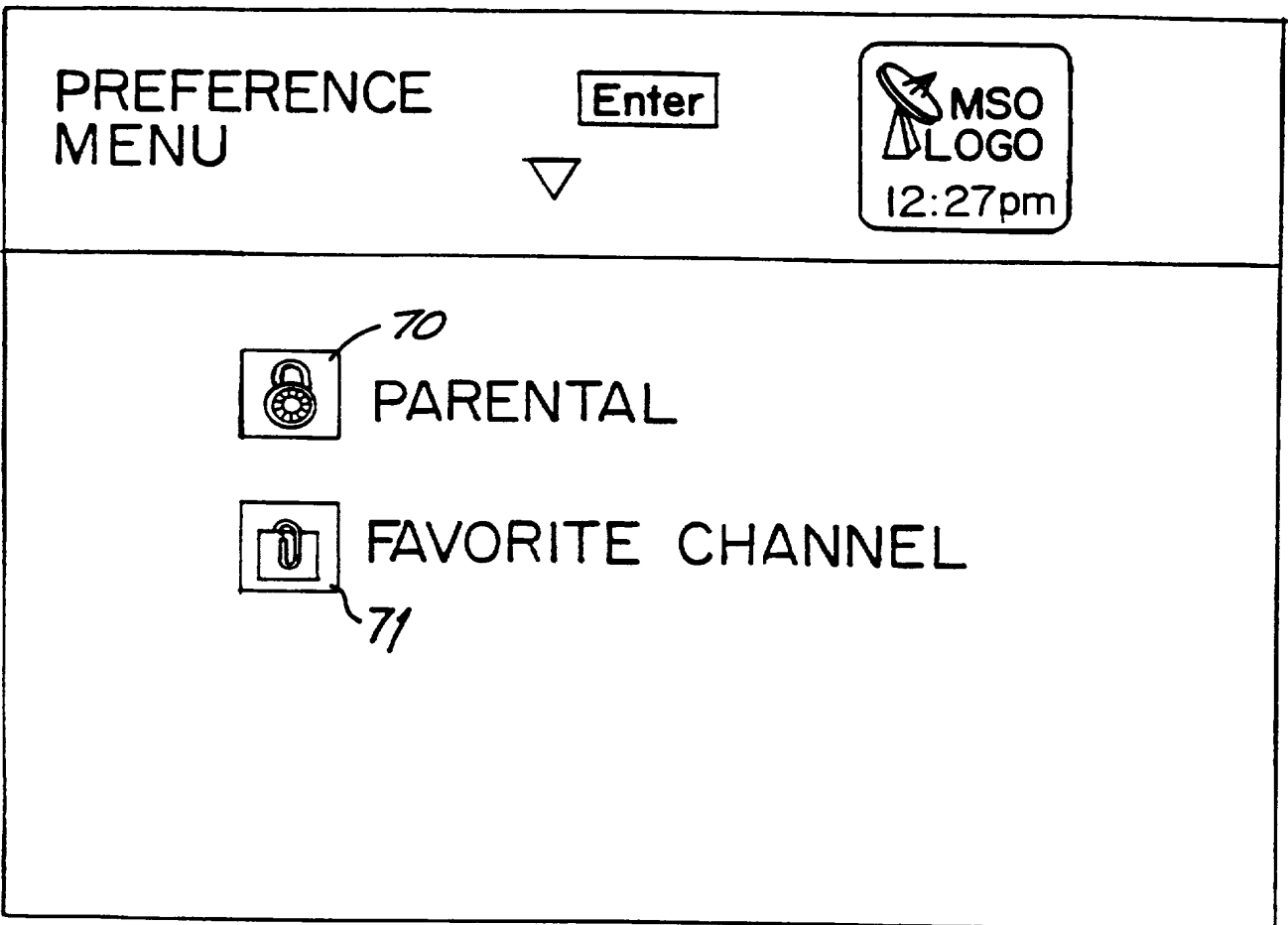

FIG.7

8/71

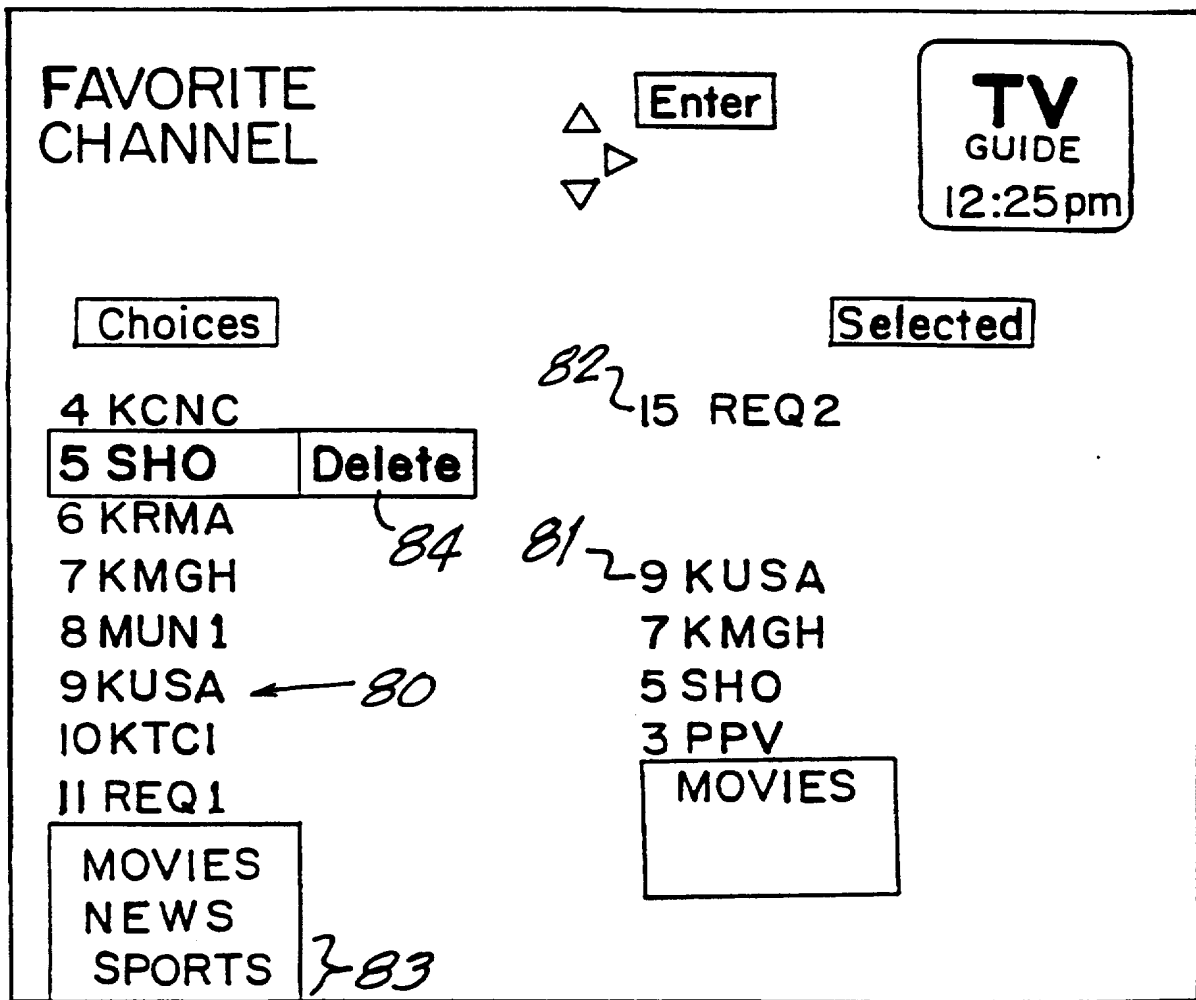

FIG.8

9/71

Jun 7

HBO is a Premium Service
To order this service press Enter

FLIP

| | | | | | | | | |
|-------------------------------------------------------------------------------------|----------------------------------------------------------------------------------------------------------------------------------------------------------------------------------------------------------|-------|-------------|------------|--|----------------------------------------------------------------------------------------------------------------------------------------------------|--------------------|---|
|  | <table border="1"><tr><td data-bbox="472 1142 716 1194">6 HBO</td><td data-bbox="737 1142 1037 1194">(4:00-5:30)</td></tr><tr><td colspan="2" data-bbox="464 1251 737 1299">Shaker Run</td></tr></table> | 6 HBO | (4:00-5:30) | Shaker Run | | <table border="1"><tr><td data-bbox="1300 1157 1427 1251">TV GUIDE</td></tr><tr><td data-bbox="1365 1268 1414 1310">i</td></tr></table> | TV GUIDE | i |
| 6 HBO | (4:00-5:30) | | | | | | | |
| Shaker Run | | | | | | | | |
| TV GUIDE | | | | | | | | |
| i | | | | | | | | |

FIG.9

10/71

| | | |
|------------------------------------------------------------------------------------|---------------------------------------------------|-------------------------------------------------------------------------------------|
| Premium Services | <input type="button" value="Enter"/> |  |
| <input type="button" value="HBO"/> | Home Box Office \$10.40/Month | |
| <input type="button" value="SHO"/> | Showtime \$9.95/Month | |
| <input type="button" value="DIS"/> | The Disney Channel \$9.95/Month | |
| <input type="button" value="TMC"/> | The Movie Channel \$1.50/Month | |
| <input type="button" value="MAX"/> | Cinemax \$9.95/Month | |
| <input type="button" value="PLA"/> | Playboy at Night \$4.95/Evening(5:00pm to 3:00am) | |
| <input type="button" value="ACT"/> | Action \$5.95/Day(11:00pm to 3:00pm) | |
| Movie, special events and family programming! | | |
| You are not a Subscriber. Press <input type="button" value="Enter"/> to Subscribe! | | |

FIG. 10

11/71

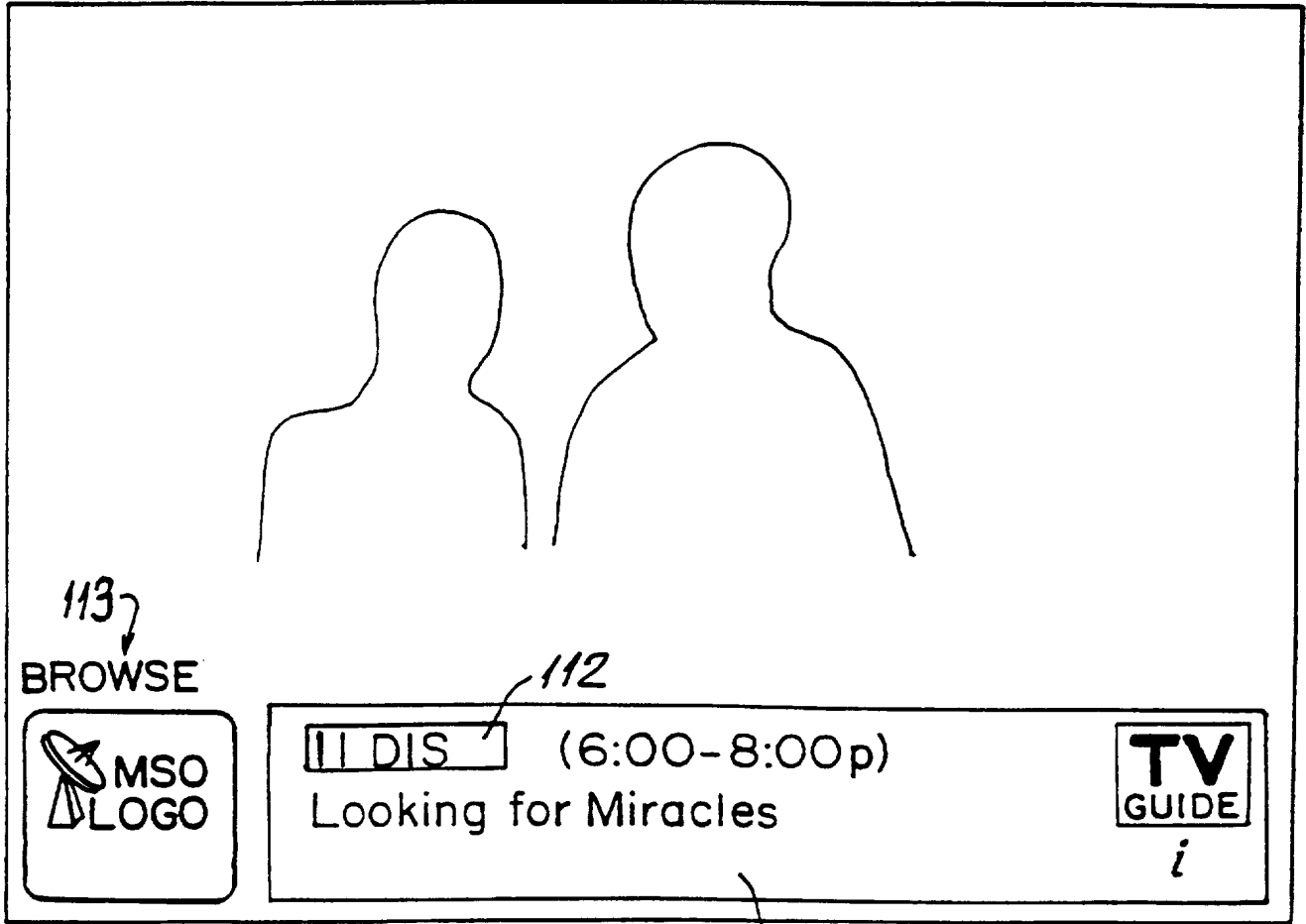

FIG. II

12/71

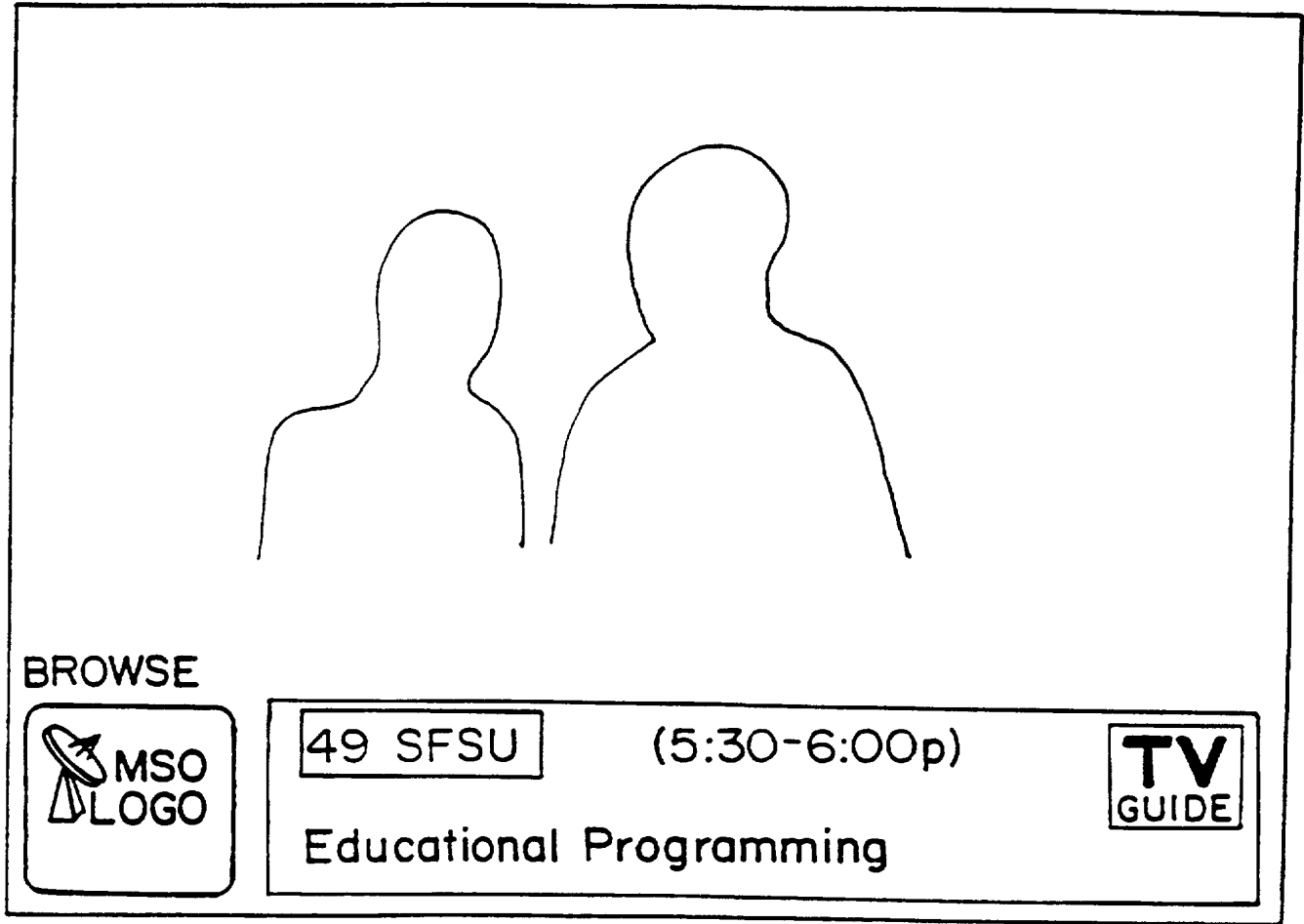

FIG. 12

13/71

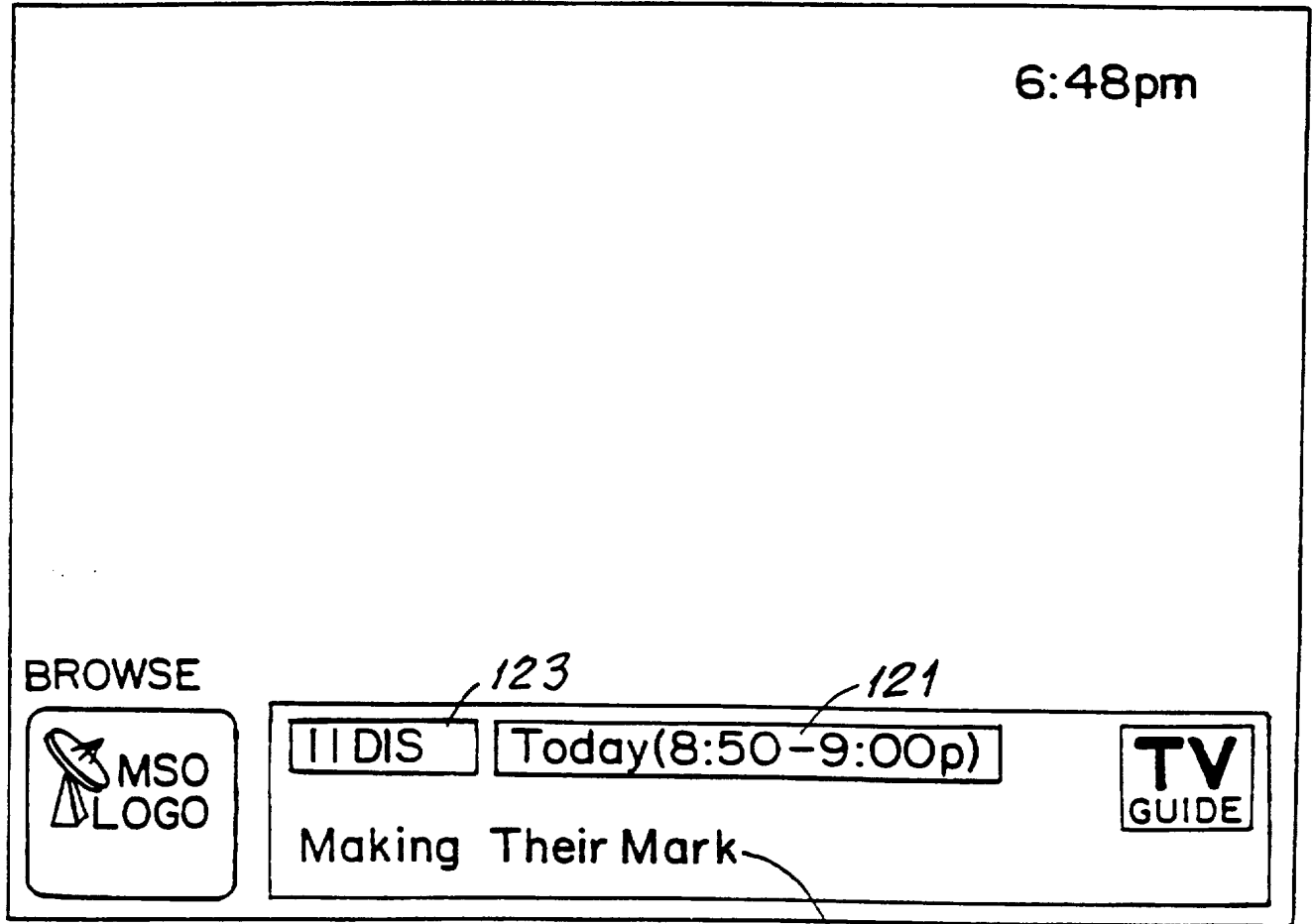

FIG. 12A

14/71

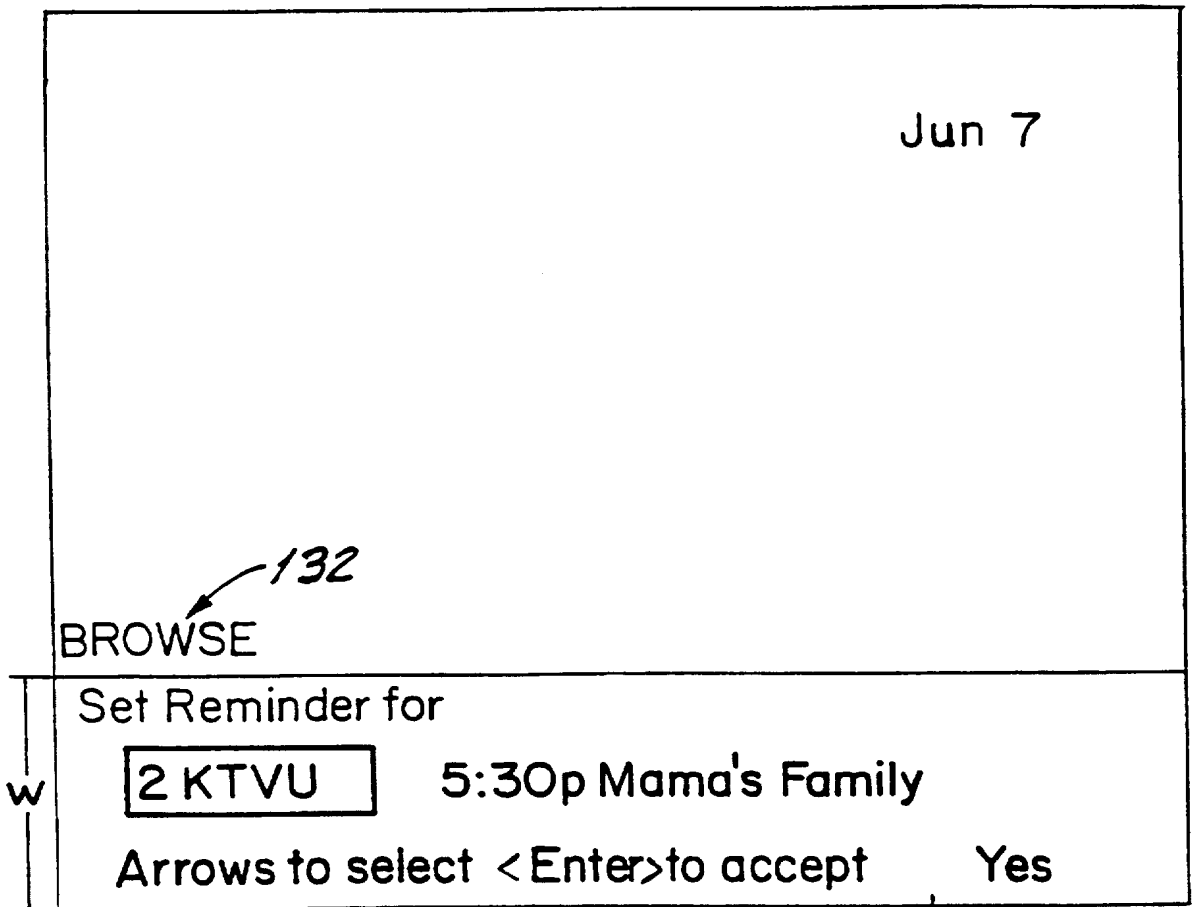

FIG.13

15/71

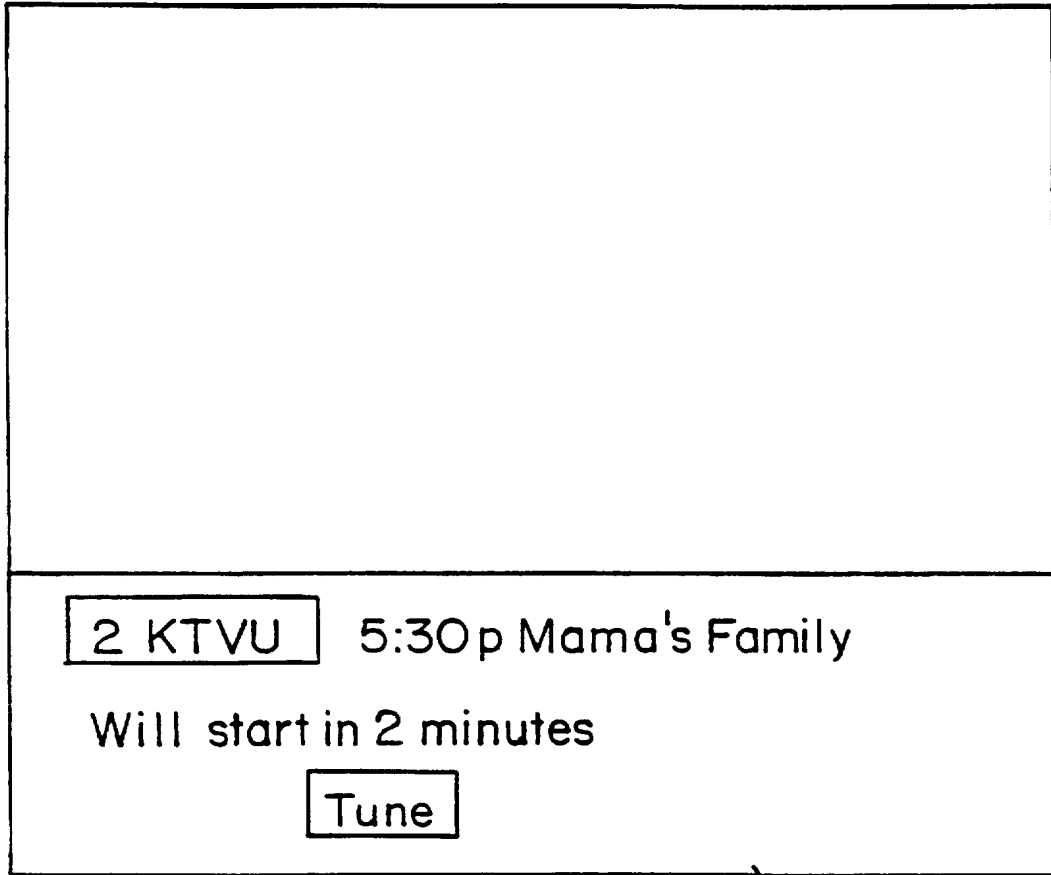

FIG.14

140

16/71

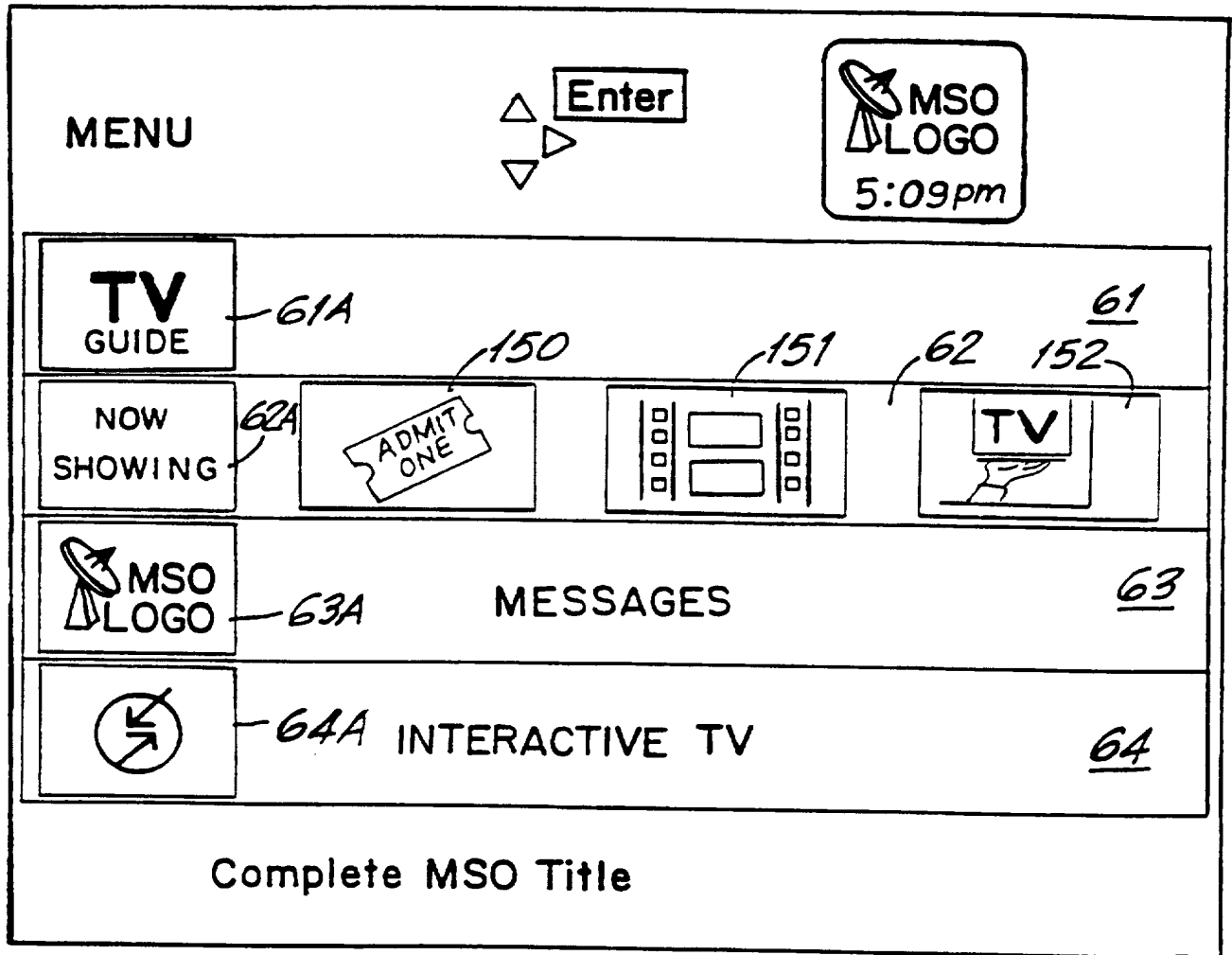

FIG.15

17/71

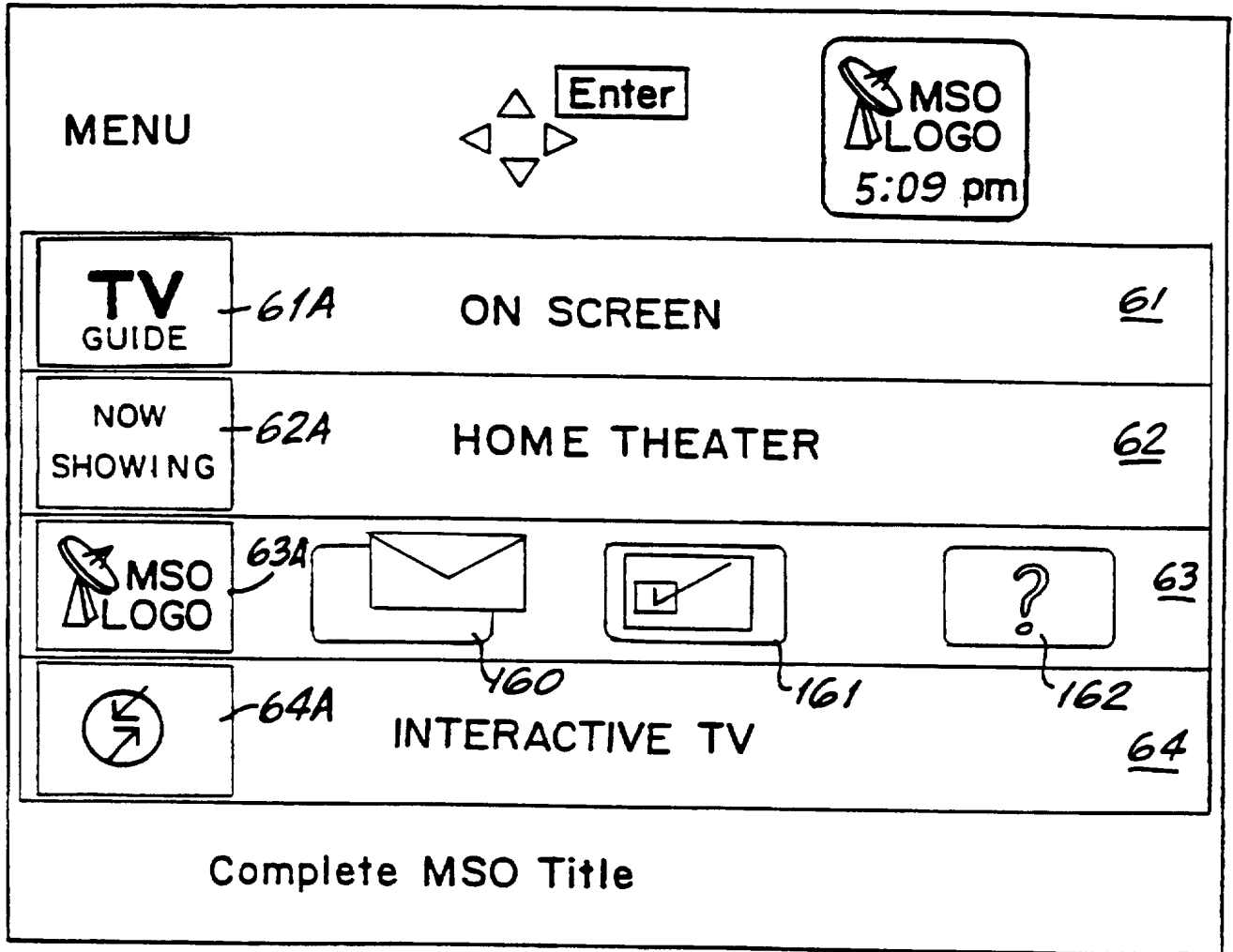

FIG.16

18/71

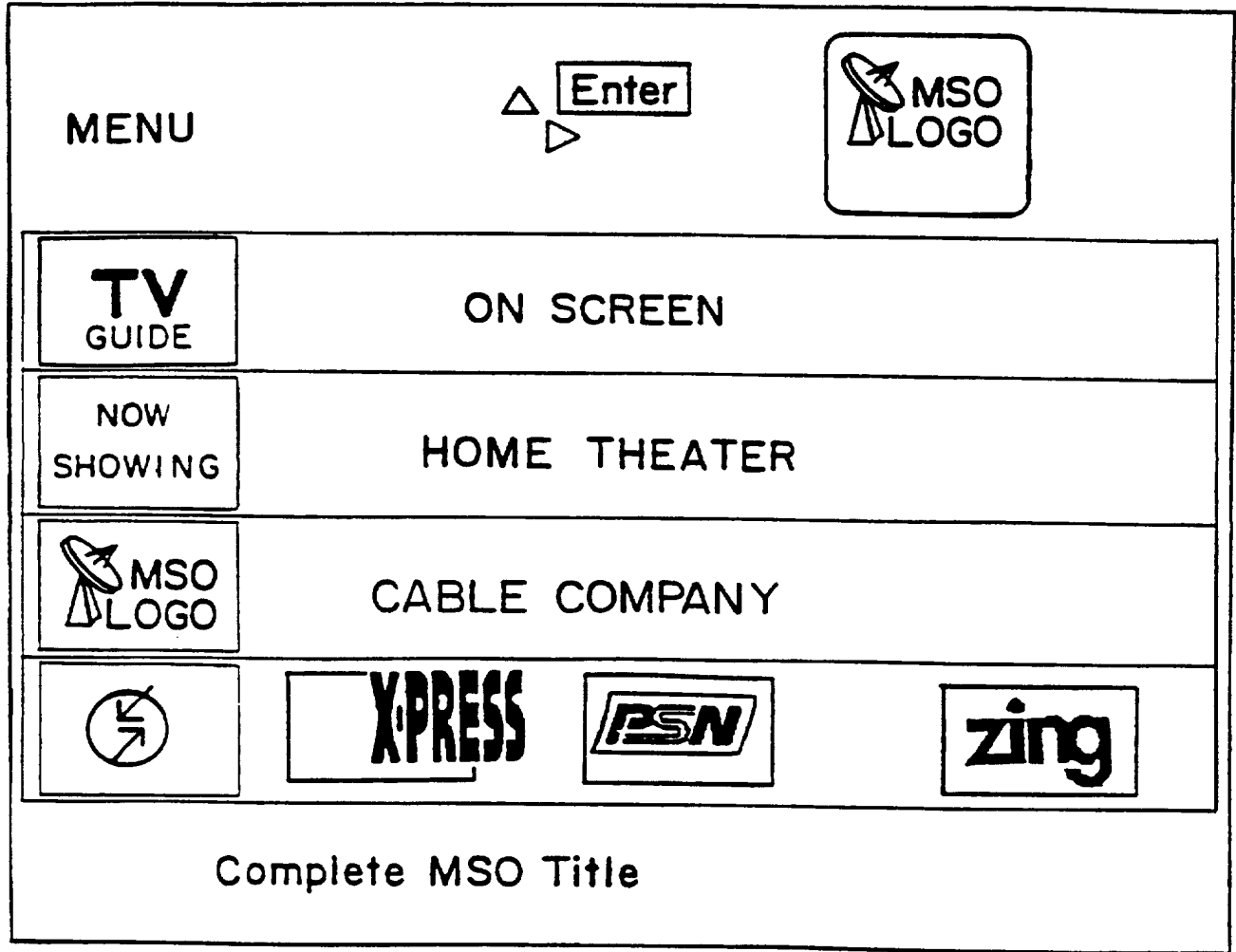

FIG.17

19/71

All-180 Listings

TV GUIDE 7:13 PM 182

Enter 184
i 183

| | | | | | |
|---------------|-------------------------|------------------|--------------|--------------|--------------|
| 4 KRON | Baseball (4:30 - 7:30p) | | | | <i>i</i> |
| Today | | 7:00p | 7:30p | 8:00p | 8:30p |
| 4 KRON | Baseball | Ent. Tonight | Fresh Prince | Blossom | |
| 5 KPIX | Evening Shade | Major Dad | Murphy Brown | | |
| 6 HBO | JFK: In His Own Words | JFK | | | |
| 7 KGO | Jeopardy! | Wheel of Fortune | Day One | | |

FIG. 18

20/71

Listings By **Category** *190A* *190B* **190D** **190C** **TV GUIDE** **5:45 pm**

Movies **Sports** **News** **Children**

Today

| | | |
|-----------------------------|-----------------------------------------|------------------------|
| <input type="text"/> 22 LIF | 4:00p A Case of Deadly Force | <input type="text"/> i |
| <input type="text"/> 1 HOT | 4:00p Ring of Fire II: Blood and Steel | <input type="text"/> i |
| <input type="text"/> 34 AMC | 4:00p Texas Across the River | <input type="text"/> i |
| <input type="text"/> 31 MAX | 4:00p The Ballad of the Sad Cafe | <input type="text"/> i |
| <input type="text"/> 8 SHO | 5:00p Big Girls Don't Cry-They Get Even | <input type="text"/> i |
| <input type="text"/> 46 BRV | 5:00p Queen of Hearts | <input type="text"/> i |
| <input type="text"/> 27 TMC | 5:00p The Roaring Twenties | <input type="text"/> i |
| <input type="text"/> 25 TBS | 5 05p No Mercy | <input type="text"/> i |

FIG. 19

2/7/71

Listings By *201*

Channel *202a, 202b, 202c*

3 PREV 4 KRON 5 KPIX

Enter

TV GUIDE 6:50 pm

Today

4:30p Baseball *203*

7:30p Entertainment Tonight

8:00p Fresh Prince

8:30p Blossom

9:00p Perry Mason: Notorious Nun *i*

11:00p News

11:30 Tonight

12:30a David Letterman

FIG. 20

22/71

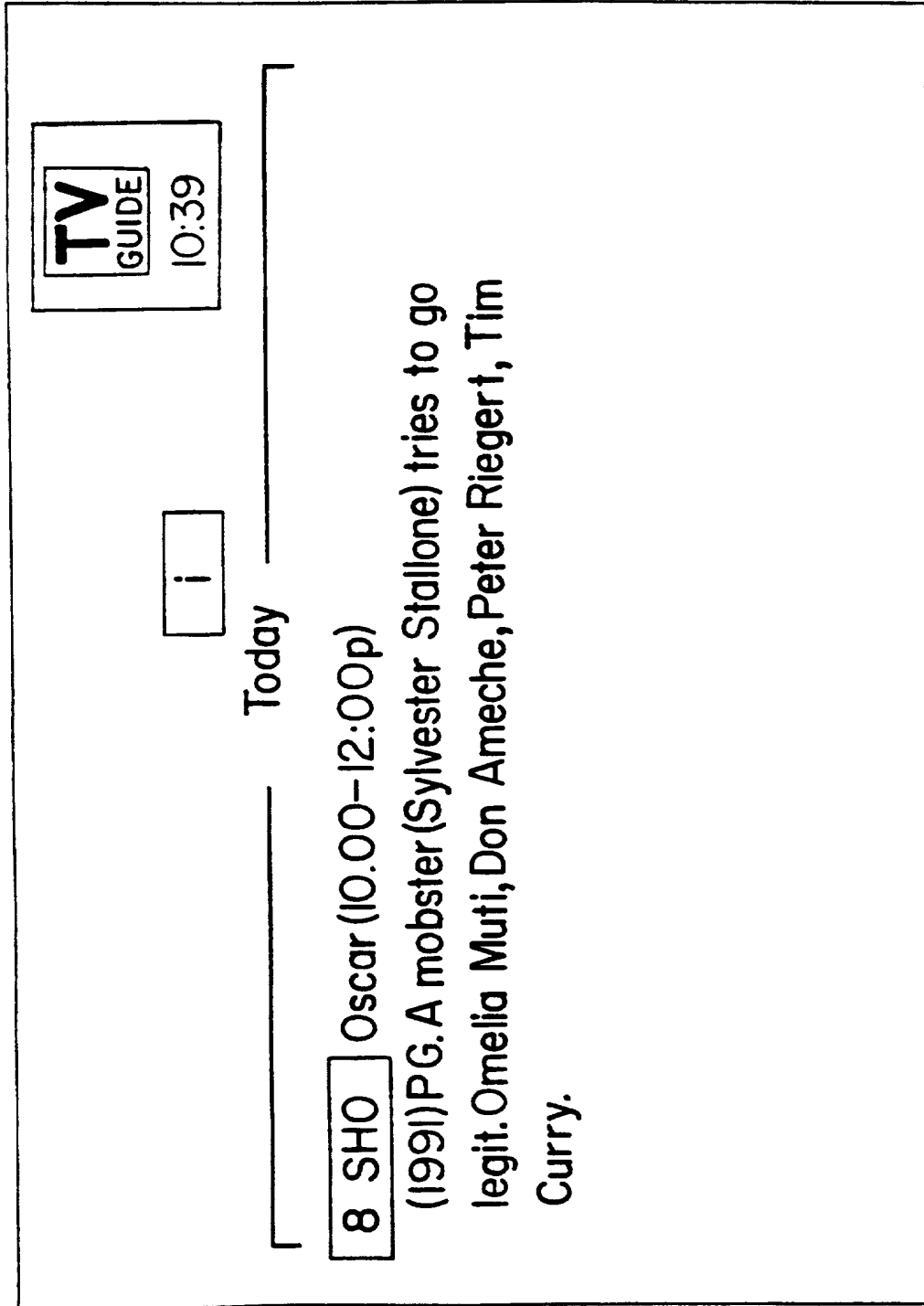
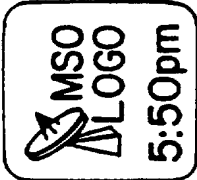

FIG. 21

23/71

PayPer View

 **MSO LOGO 5:50pm**

Select choice For Movies

Press DER! additional information

Press

Party Incorporated
 Passenger 57
 Pet Sematary Two
 Ring of Fire!Blo
 The Distinguished Ge

NOW SHOWING

220 FIG. 22

24/71

Pay Per View
Ordering

Enter

MSO LOGO
5:49 PM

\$ 3.99

Passenger 57

What time would you like this show to start?

Today 9:00p ^{230B} Tomw 12:00p Tomw 6:00p ^{230C}

230A

Would you like to see a countdown onscreen just before the show start

Yes No

| |
|----------|
| PPV / |
| / Source |

FIG.23

25/7/

Pay Per View Confirmation ◀



You have requested to order:

Passenger 57 \$ 3.99

NO, I DO NOT WANT TO ORDER.

| |
|----------|
| PPV / |
| / Source |

FIG.24

26/71

Pay Per View
Confirmation



You have requested to order:

Passenger 57 \$ 3.99

Yes, I would like to order

Passenger 57 has been Ordered!
Tune to Channel 1 Today at 9:00pm.

| | |
|-----|--------|
| PPV | / |
| / | Source |

FIG.24A

27/71



| | | | | | | |
|----------|-----------|-------------------------------------------------------------------------------------------------------------------------------------------------------------------------------|------|--------------|------|------|
| LISTINGS | |  Listing  | | 6:06P AUG 16 | | |
| 5:00 | 5:30 | 6:00 | 6:30 | 7:00 | 7:30 | 8:00 |
| NBC | 4 | News | | | | |
| ABC | 6 | News | | | | |
| CBS | 10 | CBS News | | | | |
| Fox | 28 | Club Paradise (5:00) | | | | |
| PBS | 29 | Mystery! | | | | |
| COM | 30 | Tribute to Carson | | | | |
| HBO | 33 | Gremlins 2: The New Batch | | | | |
| ESN | 34 | Tennis (4:30) | | | | |
| AMC | 35 | Arise my Love (5:00) | | | | |
| DSC | 37 | Natural World | | | | |
| NIK | 38 | I Love Lucy | | | | |

FIG.25

28/71

| | | |
|----------------------------------------------------------------------------------|---------------------------------------------------|-------------------------------------------------------------------------------------|
| Premium Services | <input type="text" value="Enter"/> |  |
| <input type="text" value="HBO"/> | Home Box Office \$10.40/Month | |
| <input type="text" value="SHO"/> | Showtime \$9.95/Month | |
| <input type="text" value="DIS"/> | The Disney Channel \$9.95/Month | |
| <input type="text" value="TMC"/> | The Movie Channel \$1.50/Month | |
| <input type="text" value="MAX"/> | Cinemax \$9.95/Month | |
| <input type="text" value="PLA"/> | Playboy at Night \$4.95/Evening(5:00pm to 3:00am) | |
| <input type="text" value="ACT"/> | Action \$5.95/Day(11:00pm to 3:00pm) | |
| Movie, special events, and family programming! | | |
| You are not a Subscriber. Press <input type="text" value="Enter"/> to Subscribe! | | |

FIG.26

29/71

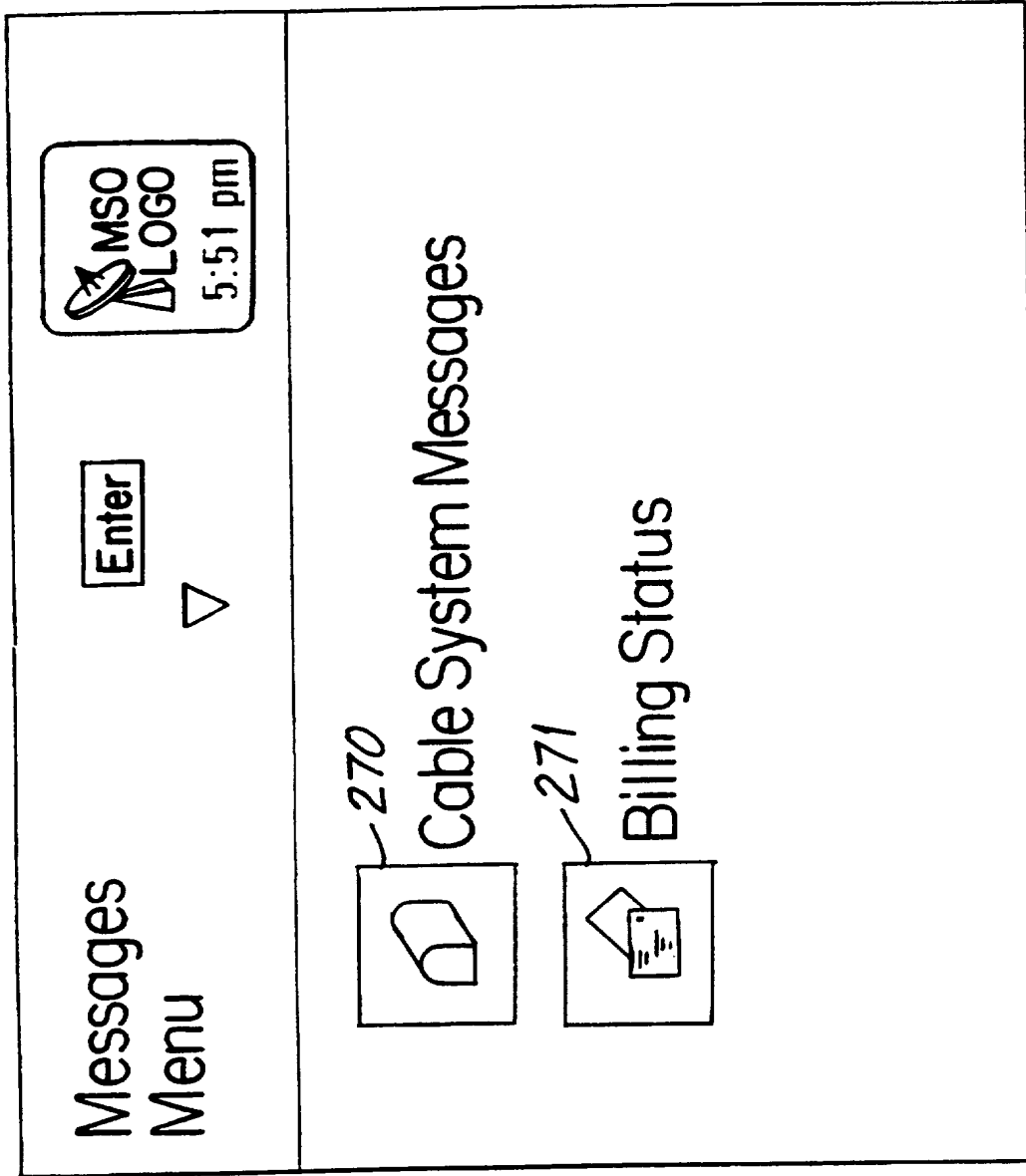

FIG.27

30/71

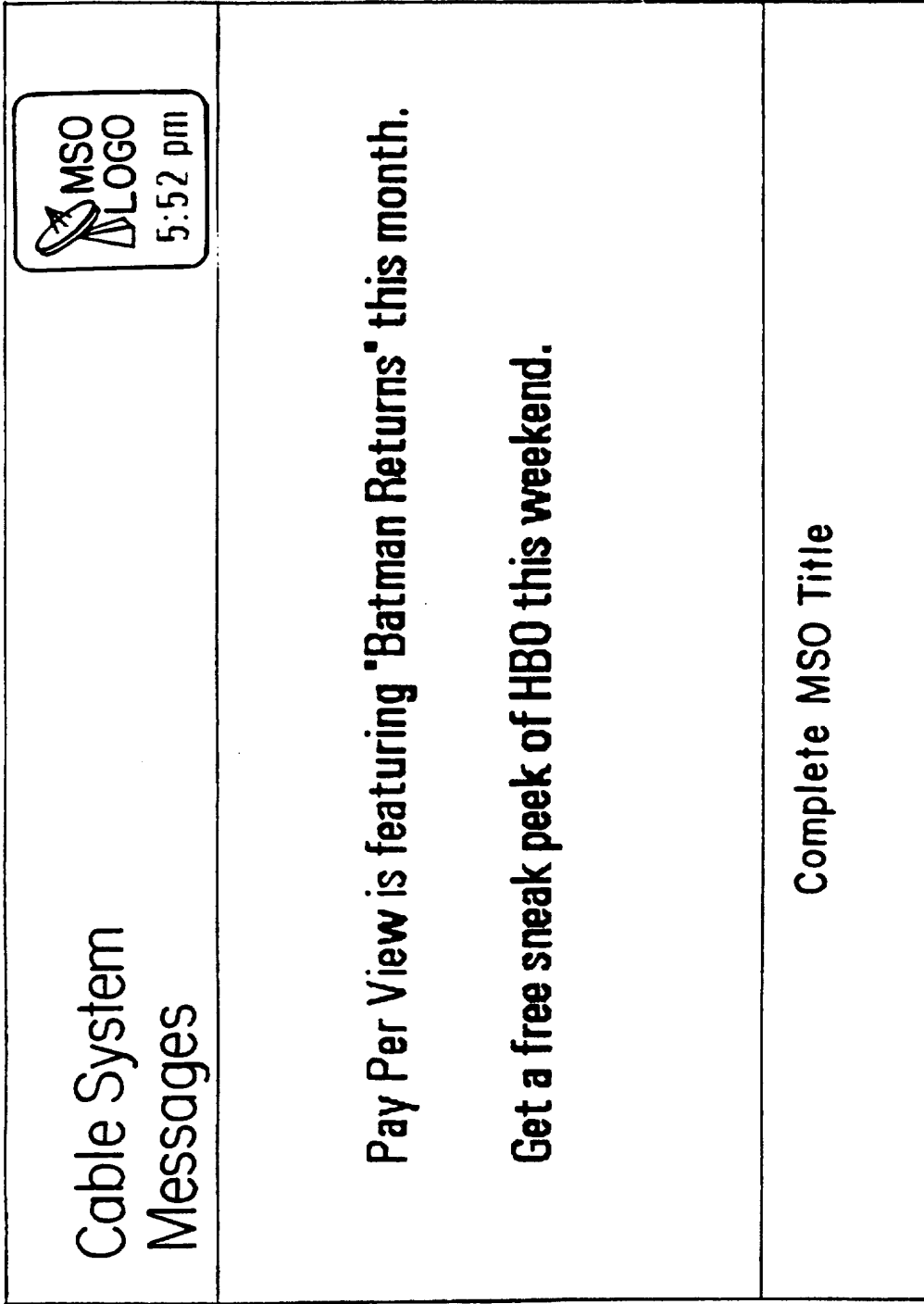
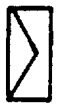
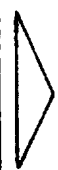

FIG.28

31/71



| | |
|-------------|-------------------------------------------------|
| 3/17 | Free HBO Preview Tonight |
| 3/22 | Pay Per View Movie Sale Will be on Tonight only |
| 2/28 | New Channel Next Week on your Cable Network |
| | |



| | |
|--------------|----------------------------------------------|
| 12/23 | California Earthquake Reeks Havoc on TV |
| 3/25 | President Clinton Address |
| 3/30 | PBS Pledge Drive Begins Tonight with Auction |
| | |



To move between cable system and TV Guide mailboxes, use Left/Right arrows. To read messages, use Down arrow: when headline is highlighted, full message appears in this space.

FIG. 28A

32/71

Billing

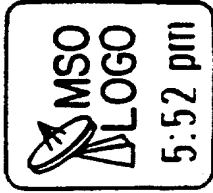

Name: TV Guide Onscreen Acct. #: 12345-098765-08-9

Billed From: 05/25/93 Billed To: 06/25/93 Total: \$3.99

FOR CUSTOMER SERVICE CALL: 790-0900

| Date | Time | Service / PPV Event | Cost |
|----------|--------|---------------------|--------|
| 06/07/93 | 9:00 p | PASSENGER 57 | \$3.99 |

FIG.29

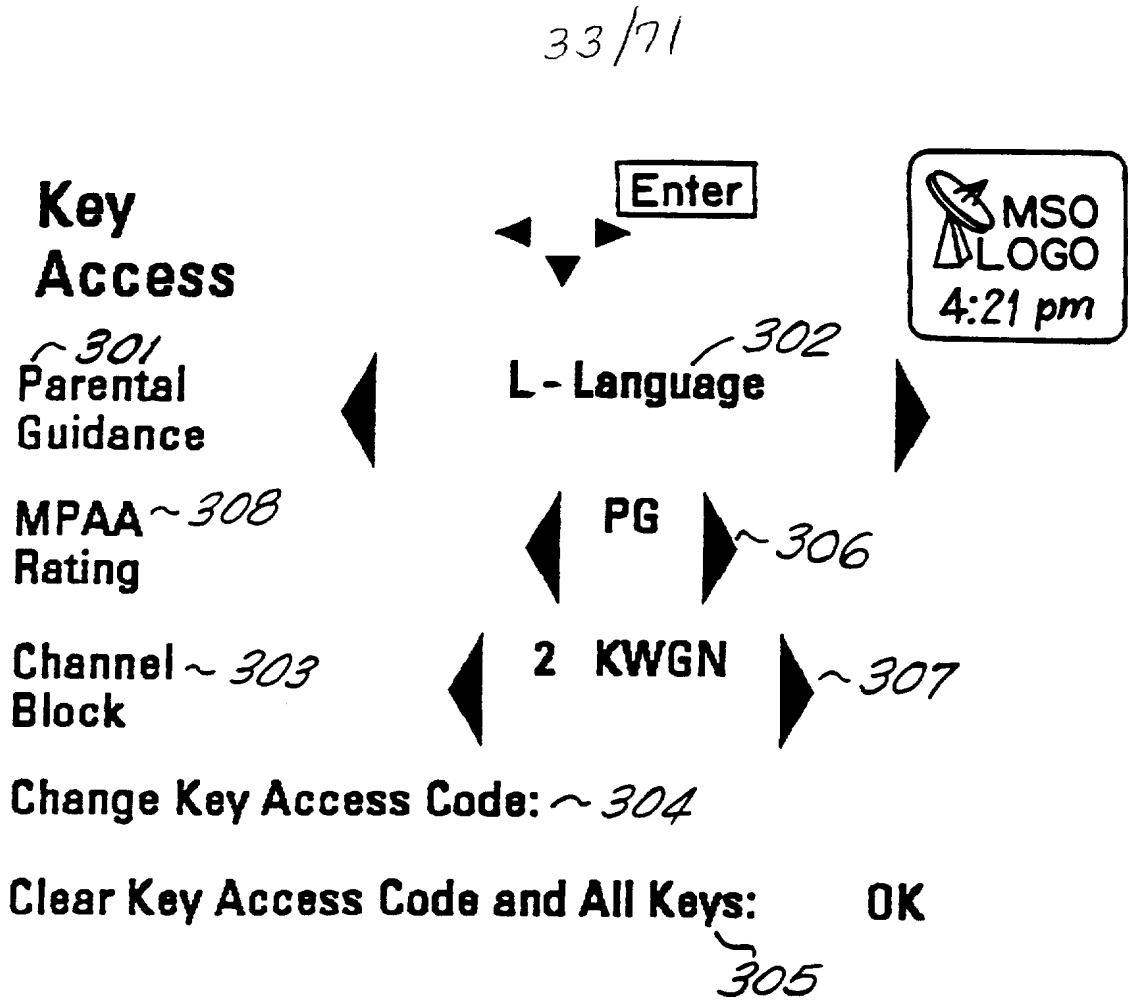

FIG.30

34/71

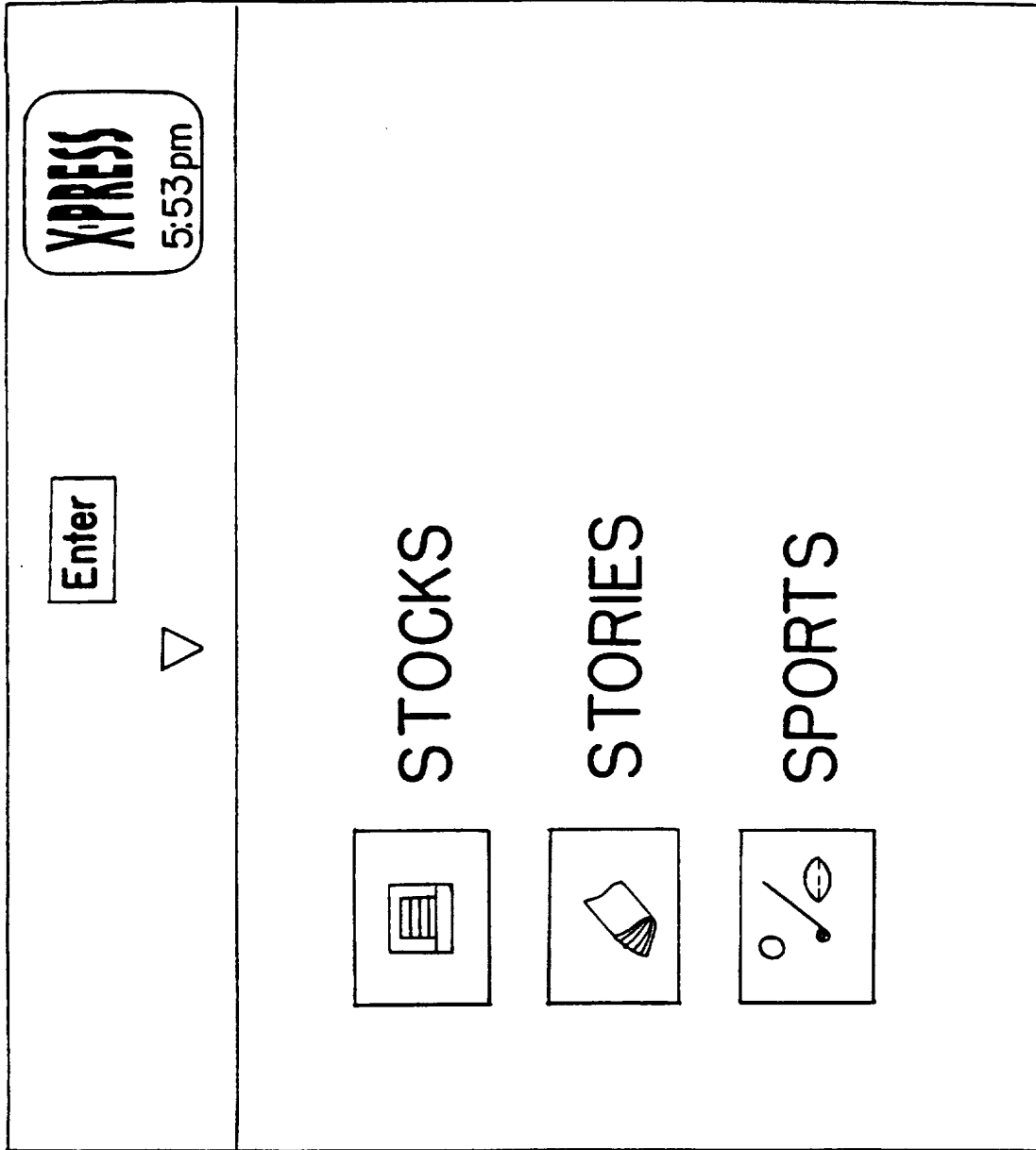

FIG. 31

35/71

Quote Watch

X-PRESS
5:53 pm

Alarms

| Symbol | Last | Vol(100s) | Change |
|--------|--------|-----------|--------|
| CMCSA | 18 | 5415 | -0.25 |
| CVC | 29.75 | 129 | -0.125 |
| JOIN | 10.5 | 22 | 0 |
| LBTYA | 18.125 | 873 | 0.625 |
| LBTYB | 18 | 0 | 1.5 |
| TCOMA | 18.25 | 22970 | -0.5 |
| TCOMB | 19.25 | 51 | -0.375 |
| TUNE | 5.375 | 407 | -0.125 |



Portfolio Value is 433200 and your gain is 443

FIG. 32

36/71

X-PRESS
5:53 pm

Last \$22.87 at
12.00pm. 05/29/93

Hi Low/Close Graph

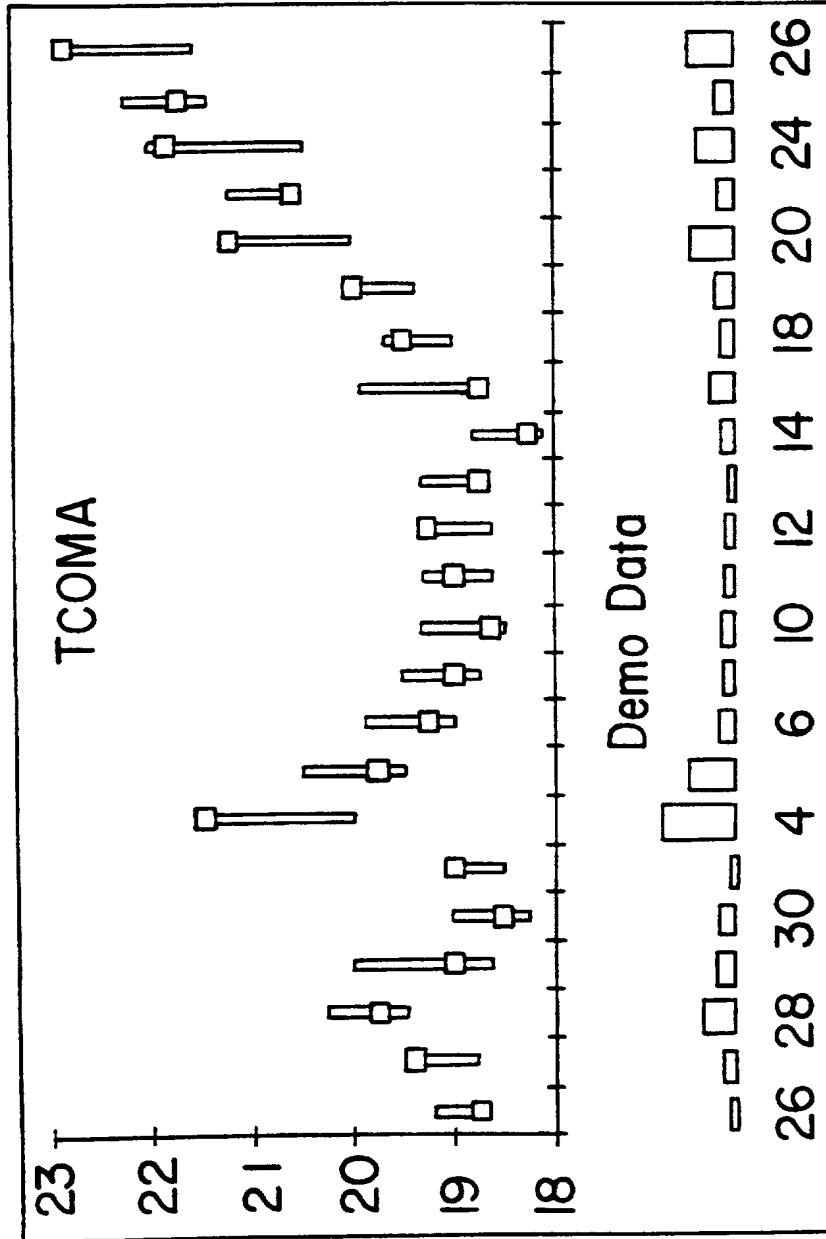

FIG. 33

37/71

STORIES

XIPRESS
Jun 7

US World News**Cubans use Vitamins to combat epidemic**

Geneva - A costly campaign to provide vitamins to all Cubans has helped curb a mysterious epidemic that has afflicted thousands with vision problems, a World Health Organization official said yesterday.

The outbreak of optical neuritis has dimmed the vision of about 20,000 Cubans and a related malady has affected 6,000 other people, mostly women.

FIG.34

38/71

SPORTS



Major League Baseball

Yesterday in National League Action

Colorado 7, Houston 5

San Francisco 5, Chicago 4

Yesterday in American League Action

Detroit 4, Boston 1

Toronto 4, Milwaukee 2

FIG.35

39/71

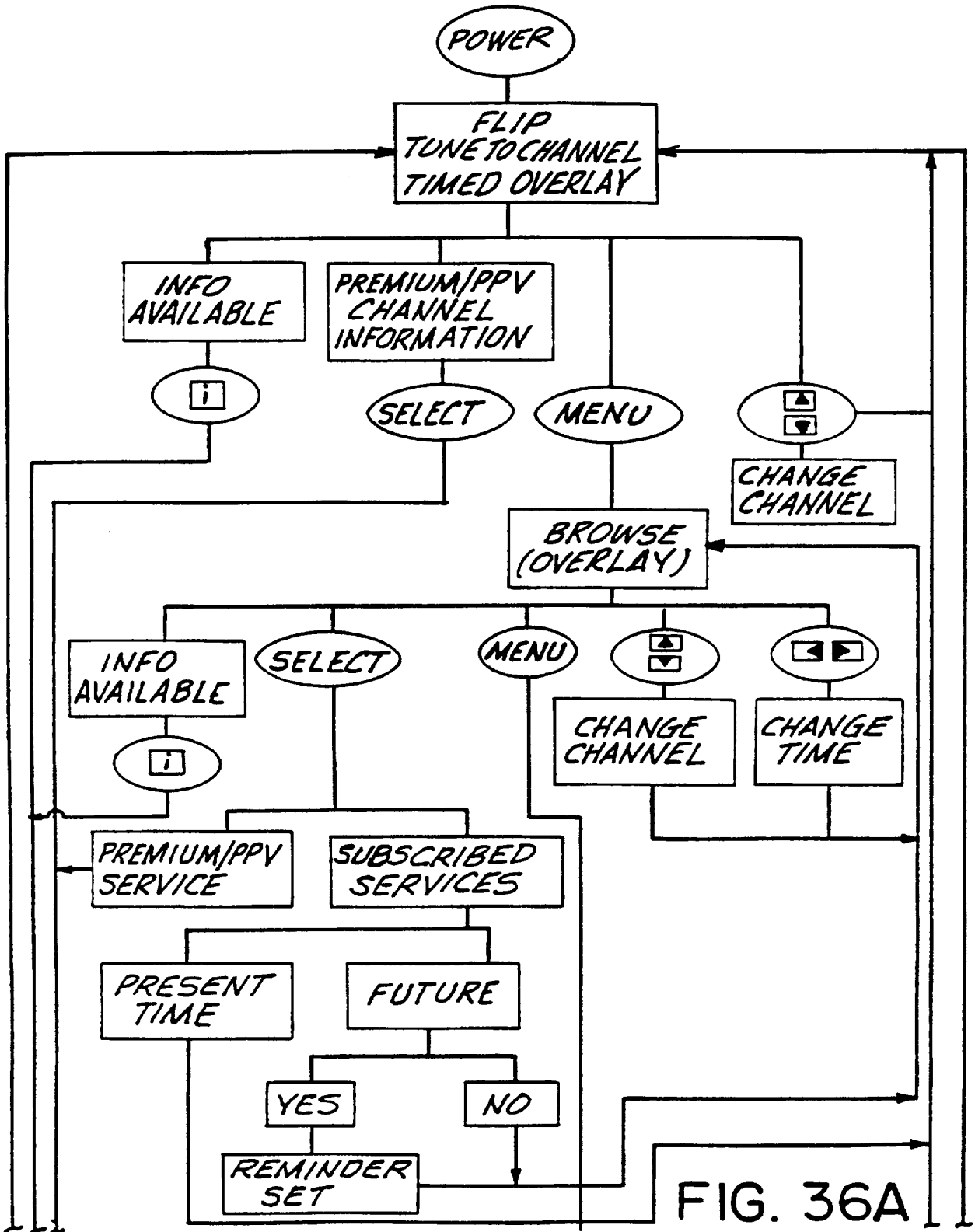

FIG. 36A

40/71

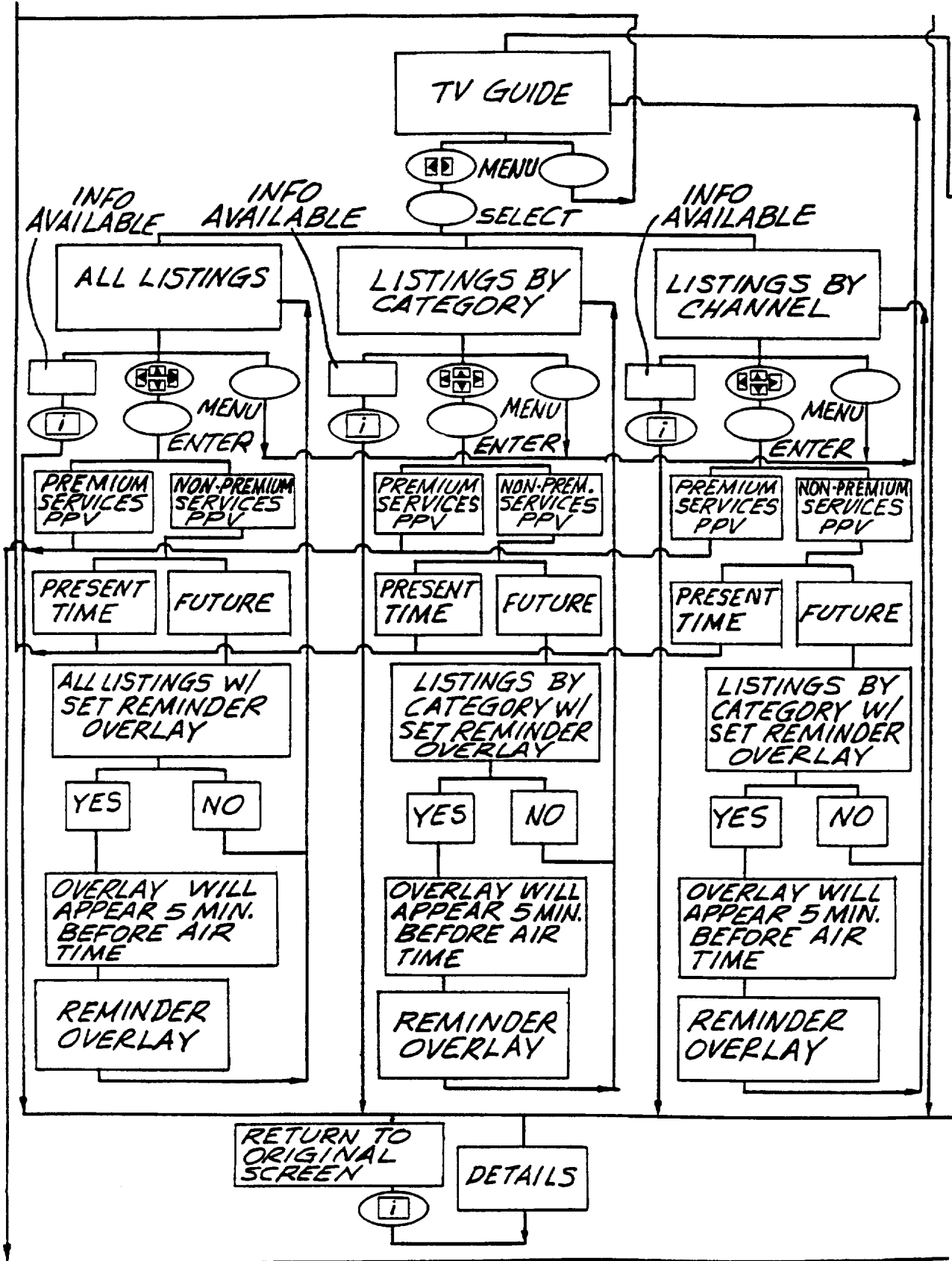

FIG. 36B

41 / 71

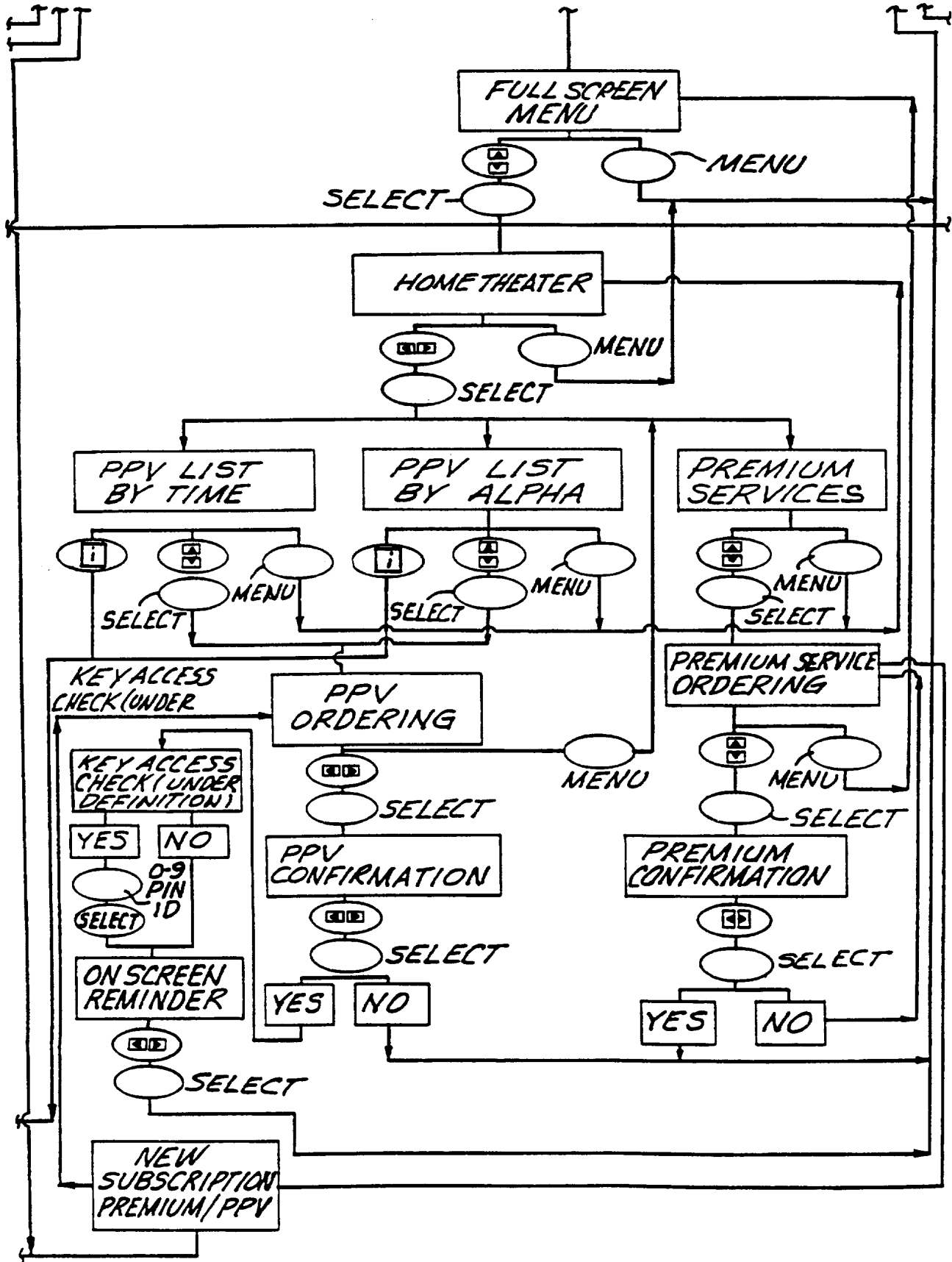

FIG. 36C

42/71

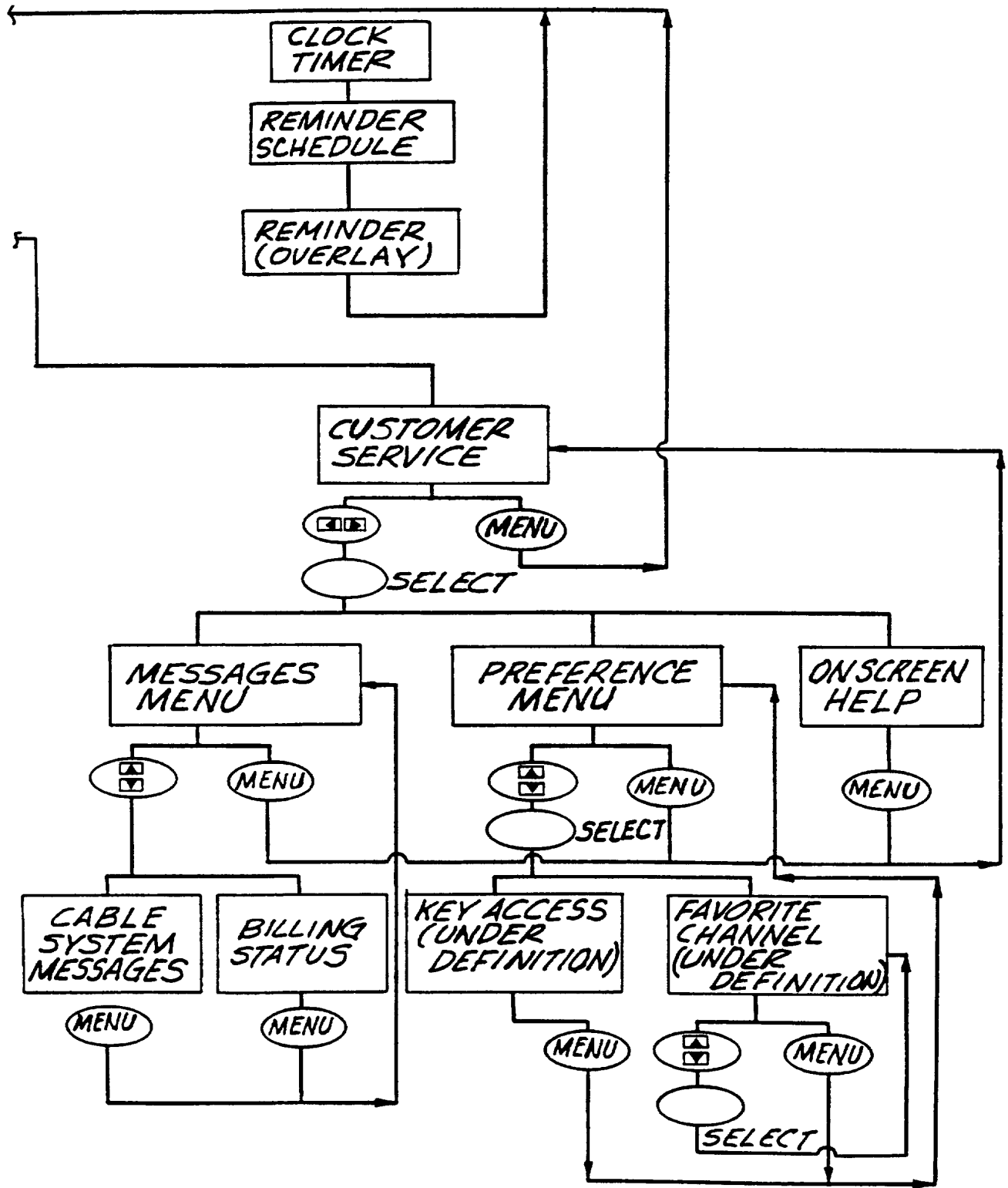



FIG. 36D

43/71

201

TV GUIDE **LOCATOR** 

| | | | | |
|------------|---------------------------------------|---------|--------|---|
| Broadcast: | ◀ <input type="text" value="2 KWGN"/> | 3 PPV | 4 KCNC | ◀ |
| Cable: | ◀ 41 A&E | 3 AMC | 24 BET | ◀ |
| Premium: | ◀ 21 DIS | 18 ENC | 14 HBO | ◀ |
| PPV: | 11 REQ1 | 15 REQ2 | | |

Clear ALL favorite channels

| | | |
|------------------|---------------------------------------|---------------------------------------|
| Favorite Channel | <input type="text" value="Included"/> | <input type="text" value="Excluded"/> |
|------------------|---------------------------------------|---------------------------------------|

Press * - Lines to illustrate text

FIG. 37

44/71

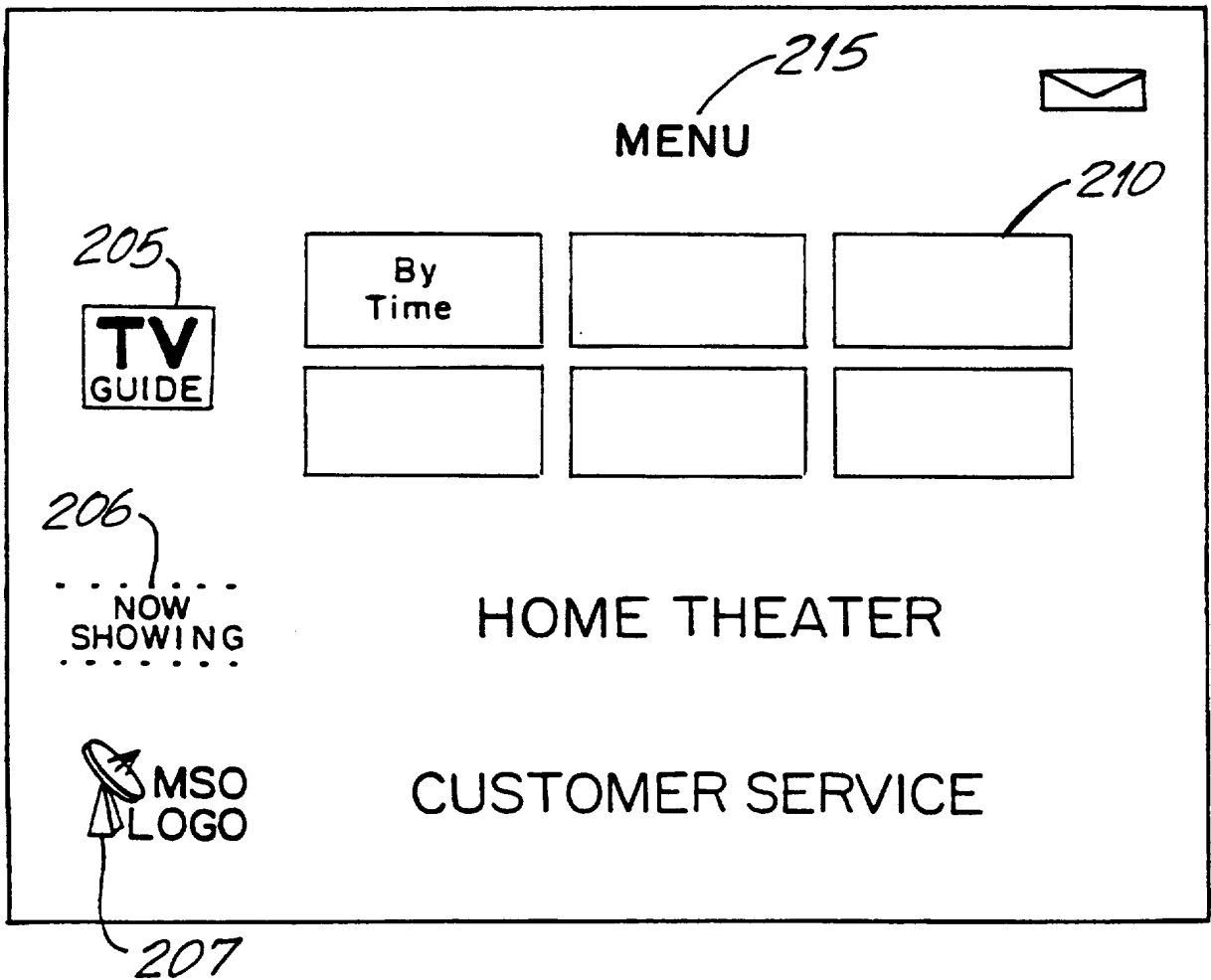

FIG.38

45/71

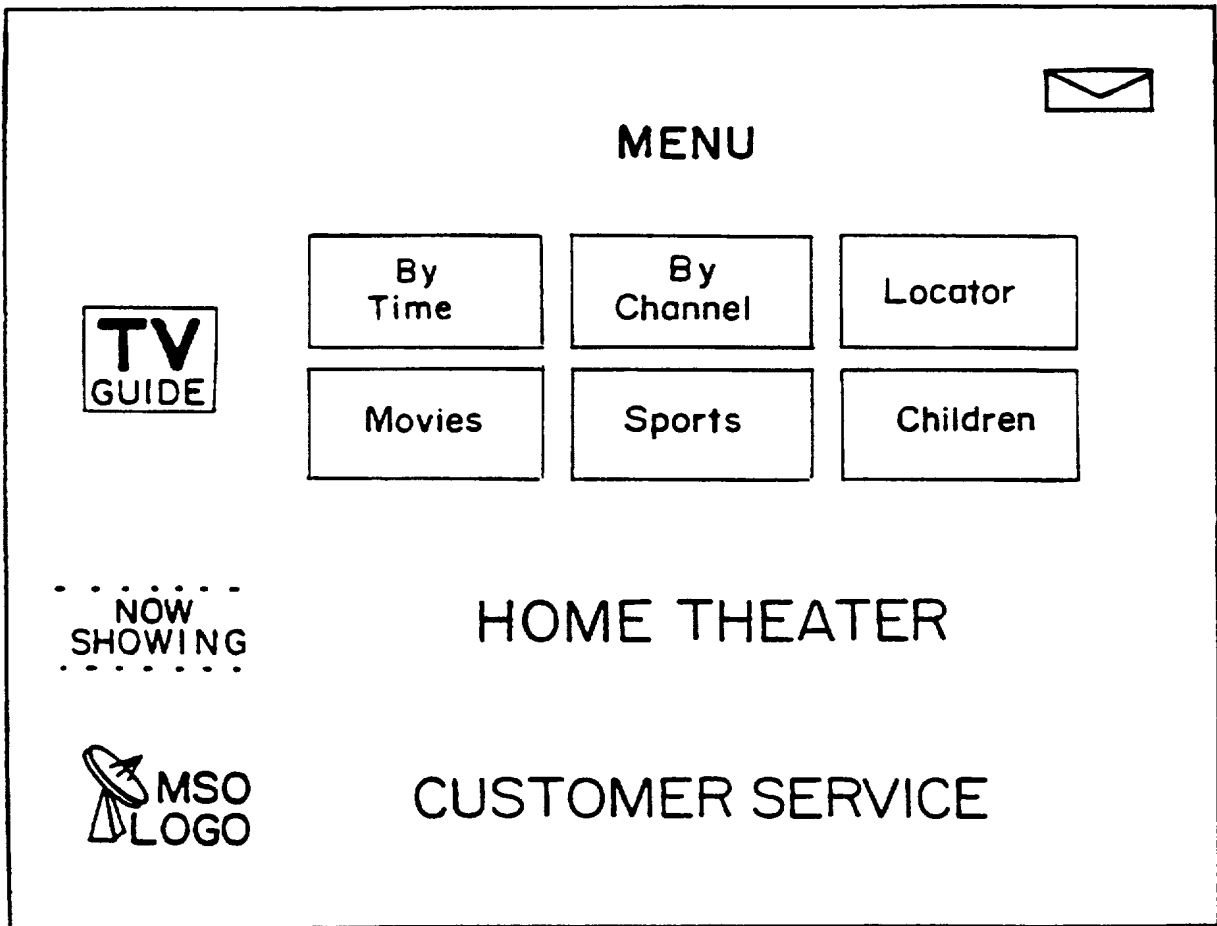





FIG.38A

46/71







TODAY 7:30PM



Extra Line

51CSPN2 Gov't Program(10-10a)

52 SPICE **Mom and Dad Save the World (4-6p)**

53 KWHD Religious Programming(12-12m)

54 MUN2 Public Access(12-12m)

2 KWGN NBA Basketball (6-30-9p)

Mom and Dad Save the World \$4.99

You have requested this program at 4PM.

To complete the ordering process,
enter your four-digit purchase code.

Purchase Code:

FIG. 38B

47/71

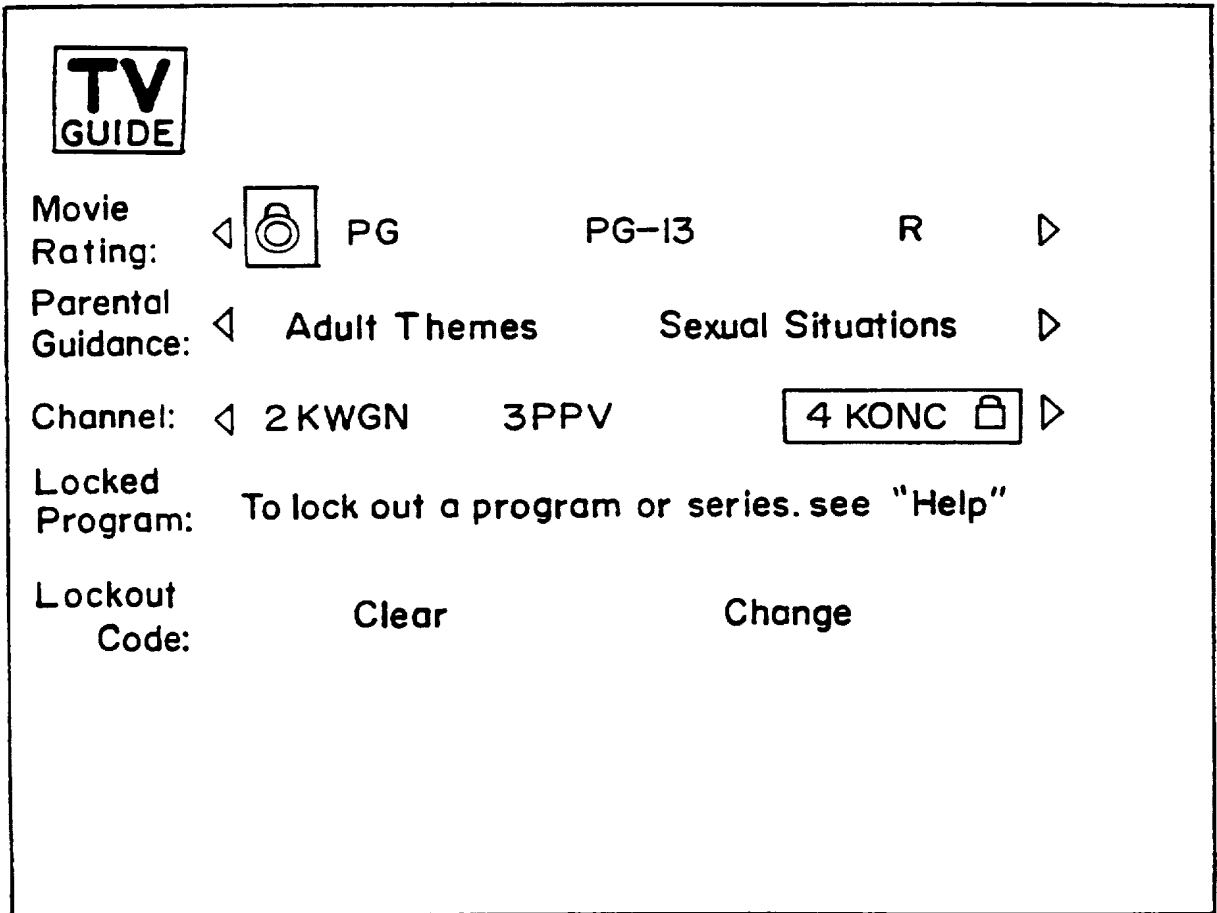

FIG. 39

48/71

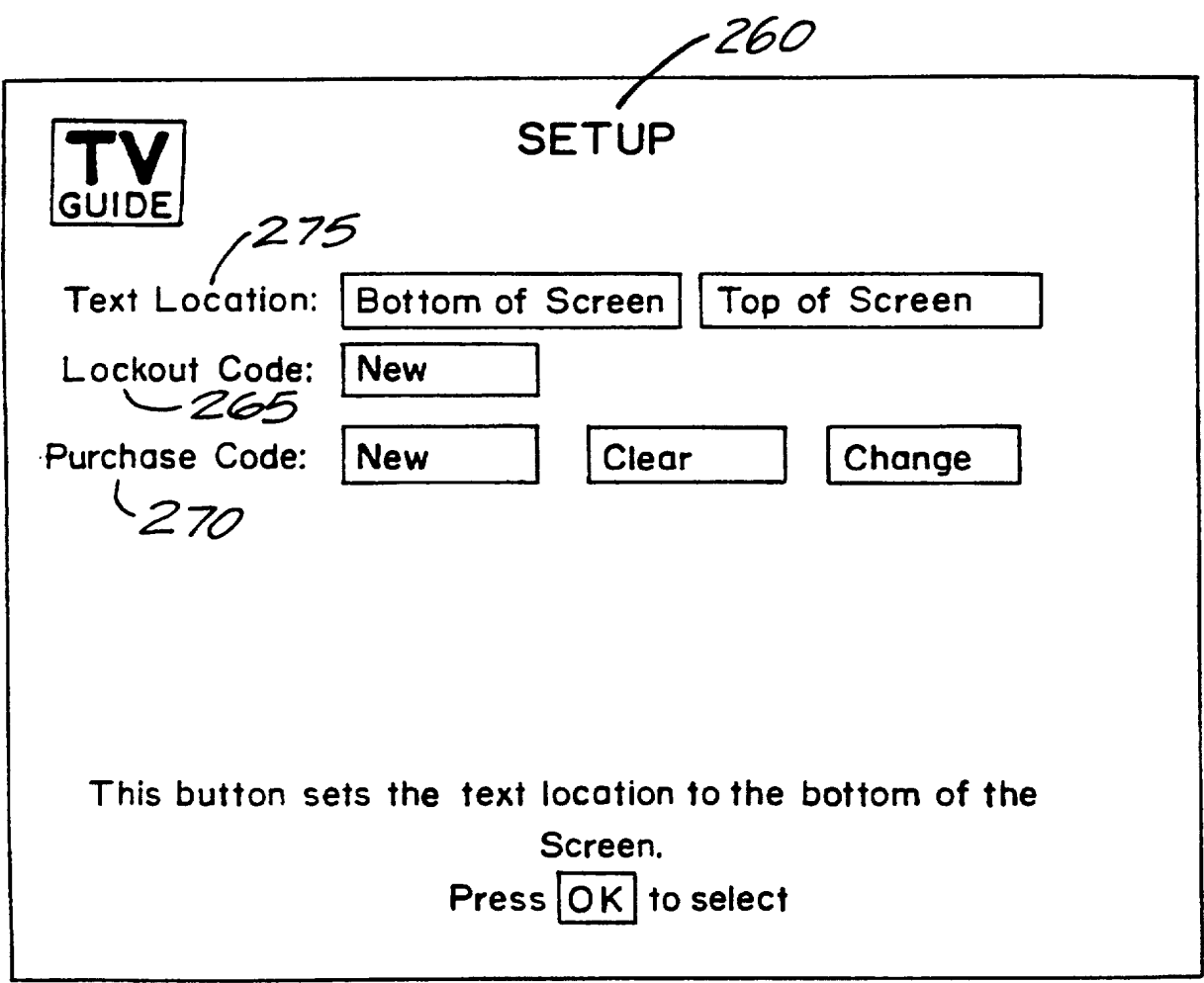

FIG. 40

49/71

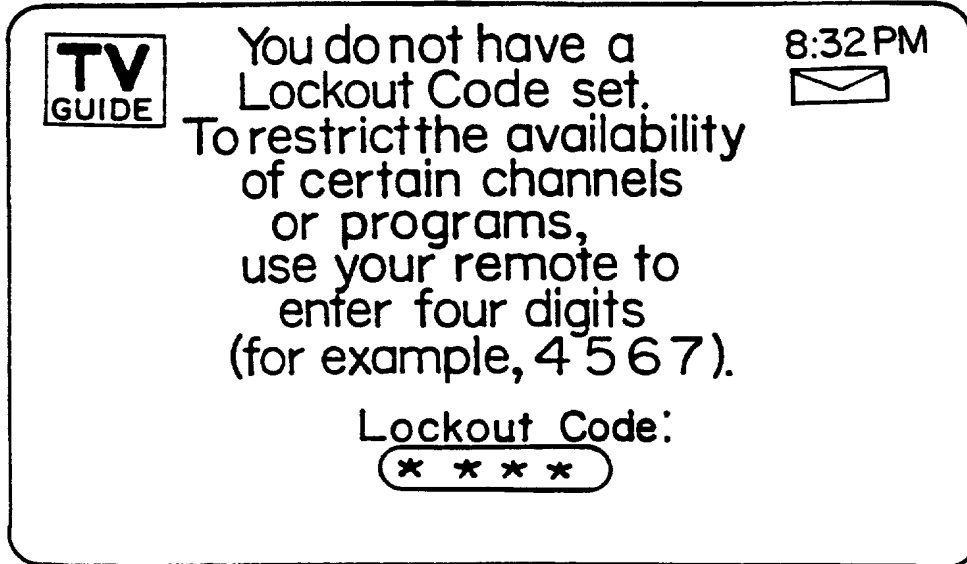

FIG.40A

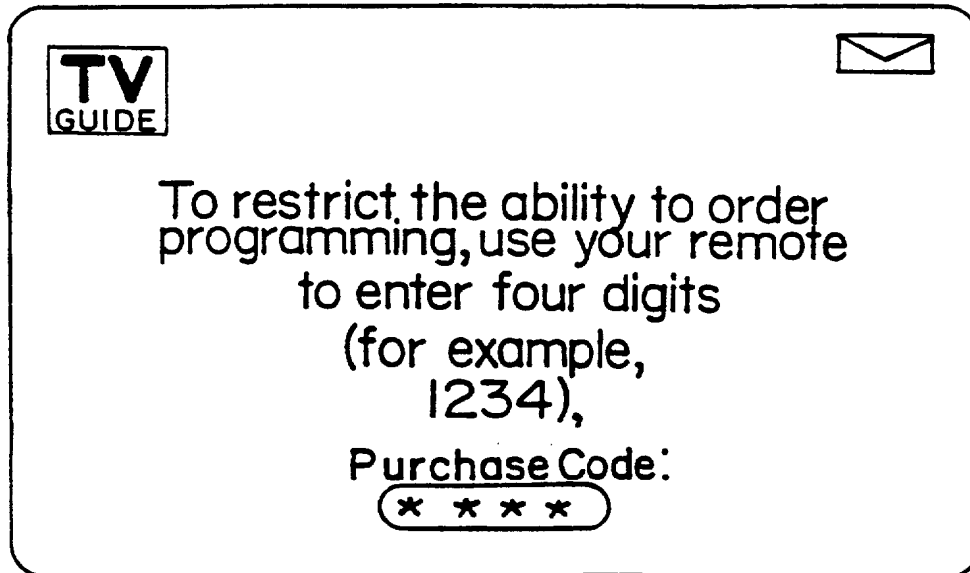

FIG.40B

50/71

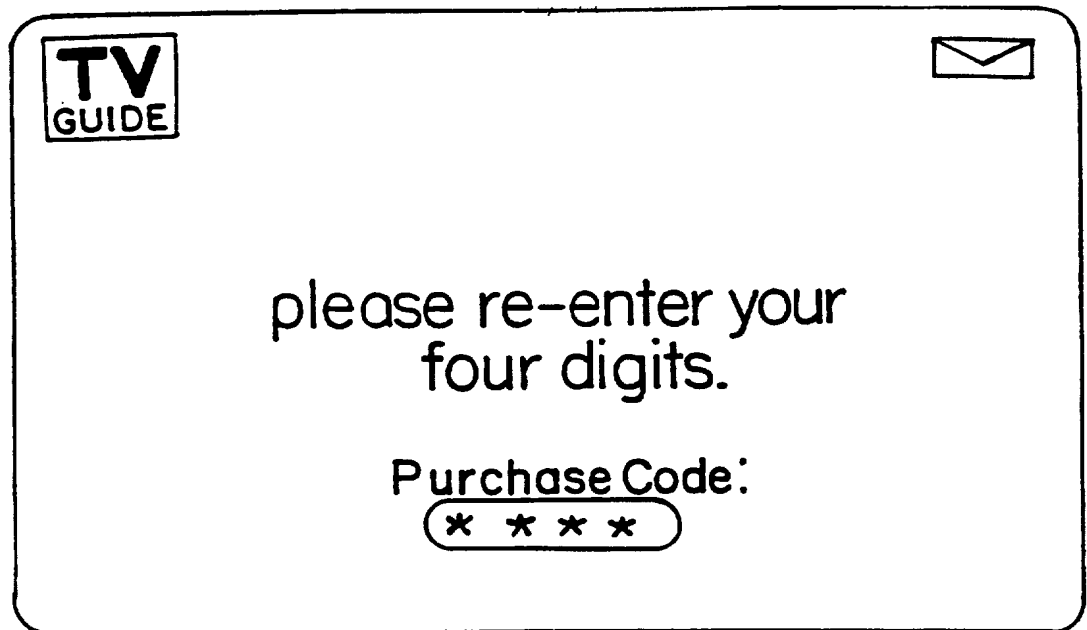

FIG.40C

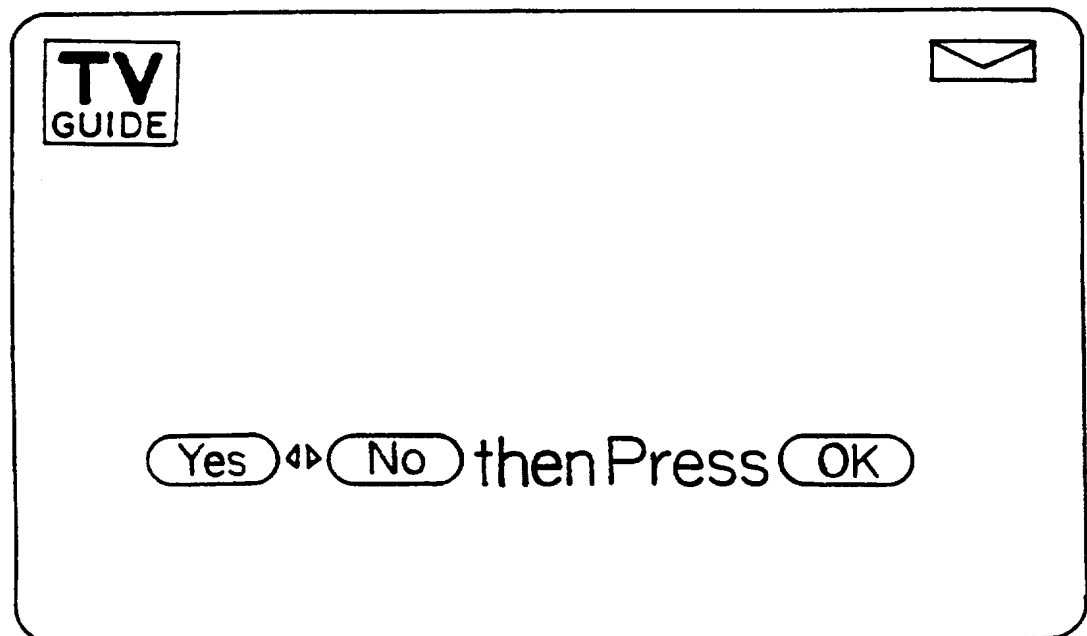

FIG.40D

51/71

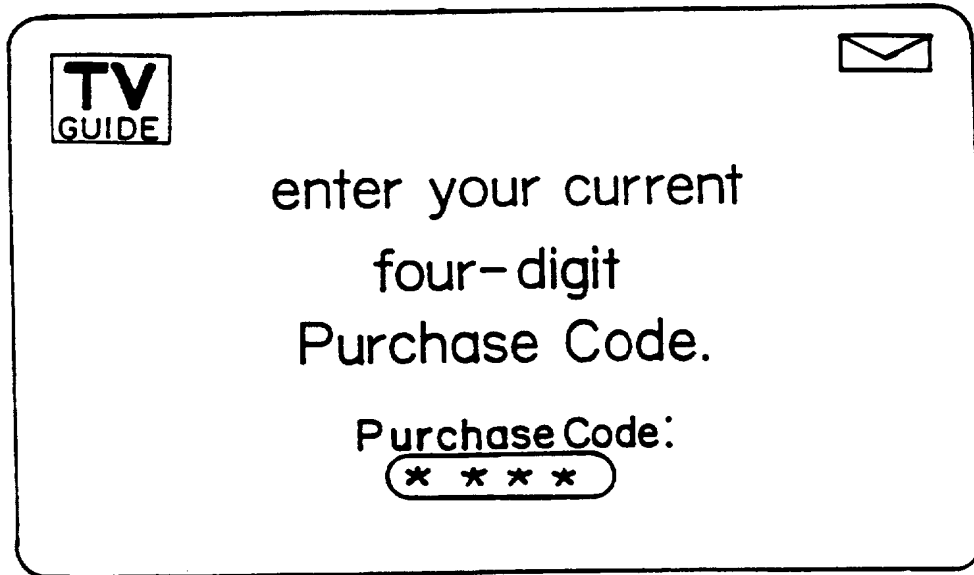
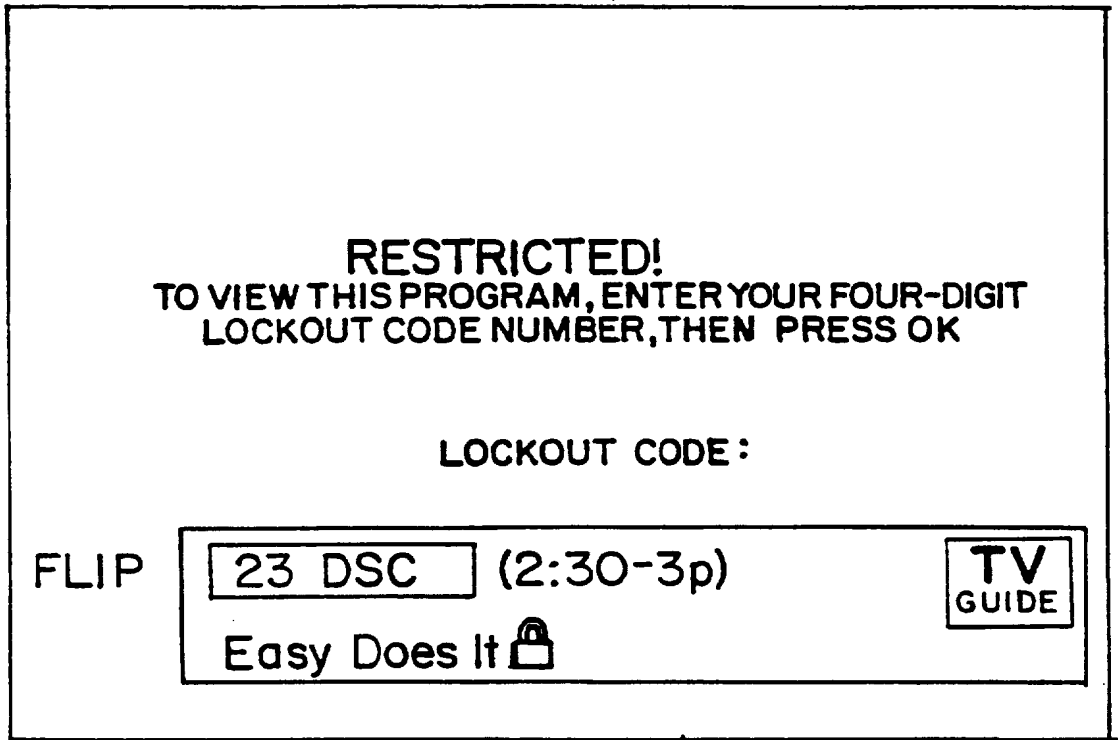

FIG.40E

52/71



300

FIG.41

53/71

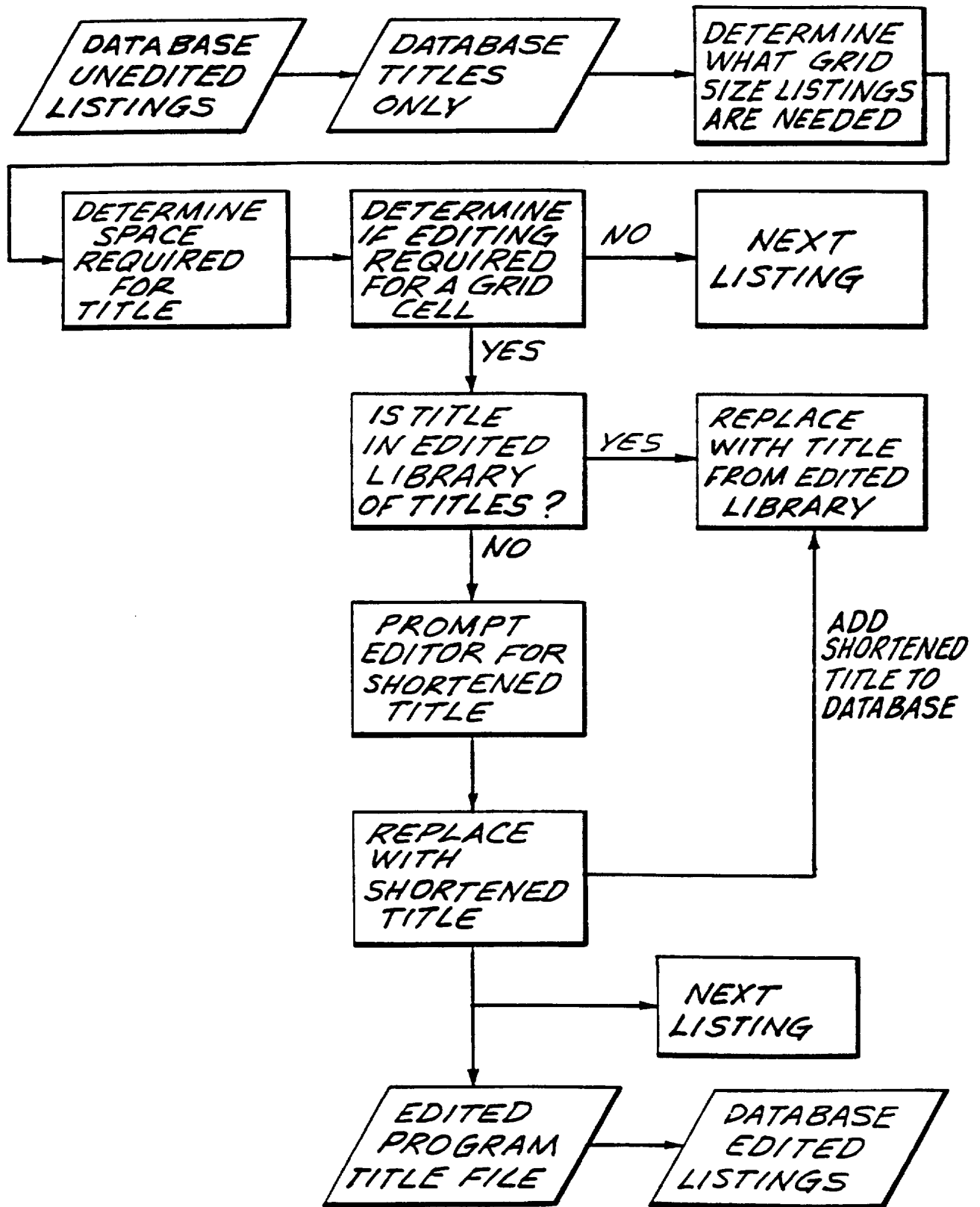

FIG. 42

54/71

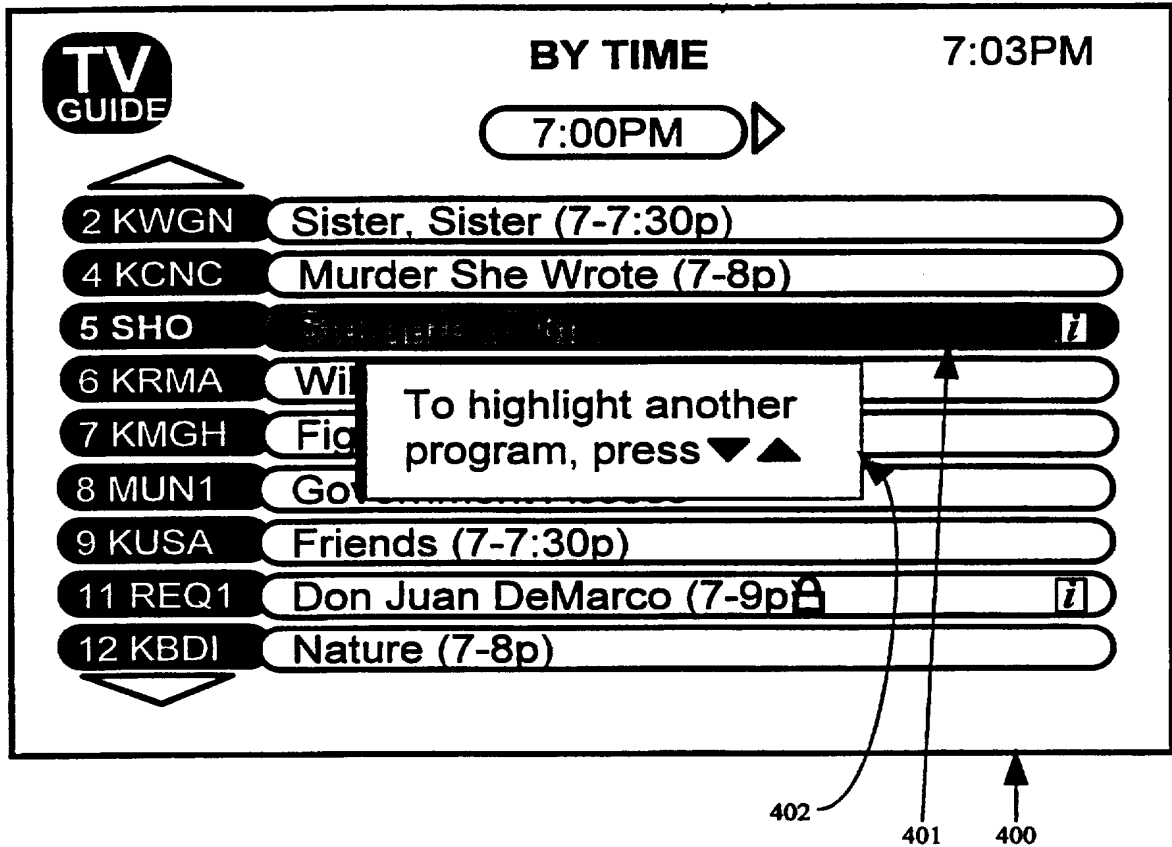

Fig. 43A

55/71

The image shows a TV Guide interface. At the top left is a 'TV GUIDE' logo. In the center, it says 'BY TIME' and '7:00PM' with a right-pointing arrow. At the top right, the current time is '7:03PM'. Below this is a list of programs, each with a channel number and a title and time slot. A pop-up message box is overlaid on the list, containing the text 'To watch this program, press OK.' and an arrow pointing to the right. The list includes:

- 2 KWGN: Sister, Sister (7-7:30p)
- 4 KCNC: Murder She Wrote (7-8p)
- 5 SHO: [faded text] [i]
- 6 KRMA: Wi [faded text]
- 7 KMGH: Fi [faded text]
- 8 MUN1: Go [faded text]
- 9 KUSA: Friends (7-7:30p)
- 11 REQ1: Don Juan DeMarco (7-9p) [i]
- 12 KBDI: Nature (7-8p)

412

410

Fig. 43B

56/71

TV GUIDE **BY TIME** **7:03PM**

7:00PM ▶

| | | |
|---------|--------------------------|-----------------------------------------|
| 2 KWGN | Sister, Sister (7-7:30p) | |
| 4 KCNC | Murder She Wrote (7-8p) | |
| 5 SHO | | i |
| 6 KRMA | Wi | For next half-hour of listings, press ▶ |
| 7 KMGH | Fig | |
| 8 MUN1 | Go | |
| 9 KUSA | Friends (7-7:30p) | |
| 11 REQ1 | Don Juan DeMarco (7-9p) | i |
| 12 KBDI | Nature (7-8p) | |

422

Fig. 43C

57/71

TV GUIDE **BY TIME** **7:03PM**

7:00PM ▶

| | | |
|---------|--------------------------|---|
| 2 KWGN | Sister, Sister (7-7:30p) | |
| 4 KCNC | Murder She Wrote (7-8p) | |
| 5 SHO | Survivor: The Island | i |
| 6 KRMA | Wildfire | |
| 7 KMGH | Fig | |
| 8 MUN1 | Gov | |
| 9 KUSA | Friends (7-7:30p) | |
| 11 REQ1 | Don Juan DeMarco (7-9p) | i |
| 12 KBDI | Nature (7-8p) | |

For more information on this program, press INFO.

432

431

Fig. 43D

58/71

TV GUIDE **BY TIME** **7:03PM**

7:00PM ▶

| | | |
|---------|--------------------------|----------|
| 2 KWGN | Sister, Sister (7-7:30p) | |
| 4 KCNC | Murder She Wrote (7-8p) | |
| 5 SHO | Survivor (6-8p) | i |
| 6 KRMA | Wil | |
| 7 KMGH | Fig | |
| 8 MUN1 | Go | |
| 9 KUSA | Friends (7-7:30p) | |
| 11 REQ1 | Don Juan DeMarco (7-9p) | i |
| 12 KBDI | Nature (7-8p) | |

To restrict viewing of this program, press LOCK.

442

Fig. 43E

59/71

TV GUIDE **BY TIME** **7:03PM**

7:00PM ▶

| | |
|---------|----------------------------------|
| 2 KWGN | Sister, Sister (7-7:30p) |
| 4 KCNC | Murder She Wrote (7-8p) |
| 5 SHO | Seinfeld (7-8p) i |
| 6 KRMA | Wil |
| 7 KMGH | Fig |
| 8 MUN1 | Go |
| 9 KUSA | Friends (7-7:30p) |
| 11 REQ1 | Don Juan DeMarco (7-9p) i |
| 12 KBDI | Nature (7-8p) |

To return to previous screen, press LAST

452

Fig. 43F

60/71

TV GUIDE **BY TIME** **7:03PM**

7:00PM ▶

| | | |
|---------|--------------------------|----------|
| 2 KWGN | Sister, Sister (7-7:30p) | |
| 4 KCNC | Murder She Wrote (7-8p) | |
| 5 SHO | | H |
| 6 KRMA | Wil | |
| 7 KMGH | Fig | |
| 8 MUN1 | Go | |
| 9 KUSA | Friends (7-7:30p) | |
| 11 REQ1 | Don Juan DeMarco (7-9p) | H |
| 12 KBDI | Nature (7-8p) | |

To watch television press EXIT.

462

Fig. 43G

61/71

The image shows a TV Guide interface titled "BY TIME" with the current time "7:03PM" and a mail icon. A navigation bar shows "Tmw" and a time selector set to "8:00PM". A list of programs is displayed with their respective channels and times. A dialog box is overlaid on the list, prompting the user to set a reminder for a program.

| Channel | Program | Time |
|---------|------------------|---------|
| 2 KWGN | Sister, Sister | 8-8:30p |
| 4 KCNC | Murder She Wrote | 8-9p |
| 5 SHO | Smallville | 7-8p |
| 6 KRMA | Wild America | 8-8:30p |
| 7 KMGH | Figure It Out | 7-9p |
| 8 MUN1 | Gov | 8-9p |
| 9 KUSA | Friends | 8-8:30p |
| 11 REQ1 | Don Juan DeMarco | 7-9p |
| 12 KBDI | Nature | 8-9p |

Dialog box text: "To set a Reminder for this program, press OK"

472

Fig. 43H

62/71

TV GUIDE BY TIME 7:03PM

7:00PM

Tmw

| | | |
|---------|------------------|---------|
| 2 KWGN | Sister, Sister | 7-7:30p |
| 4 KCNC | Murder She Wrote | 7-8p |
| 5 SHO | Stargate | i 6-8p |
| 6 KRMA | Wild America | 7-7:30p |
| 7 KMGH | Figure | 7-9p |
| 8 MUN1 | Gover | |
| 9 KUSA | Friends | 7-7:30p |
| 11 REQ1 | Don Juan DeMarco | 7-9p |
| 12 KBDI | Nature | 7-8p |

To purchase this program, press **OK**

482 481 480

Fig. 43I

63/71

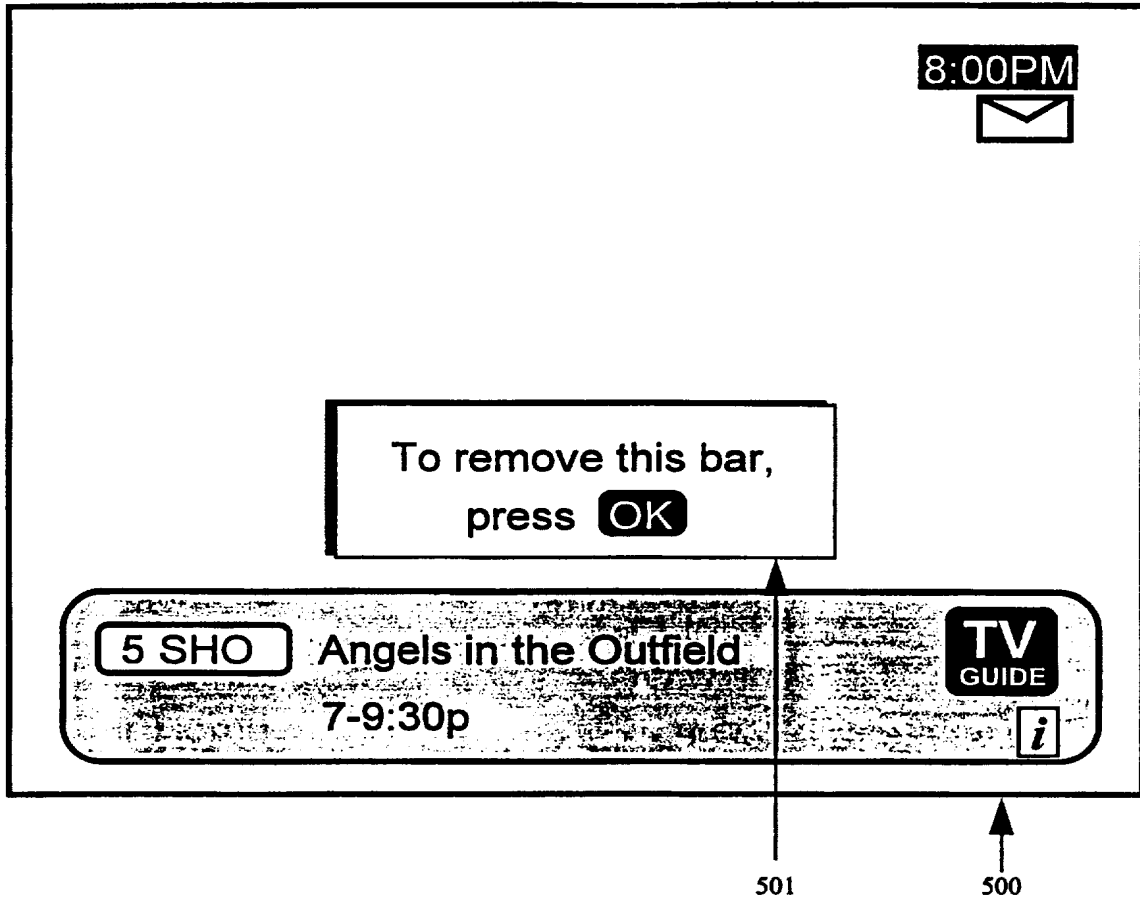

Fig. 44A

64/71

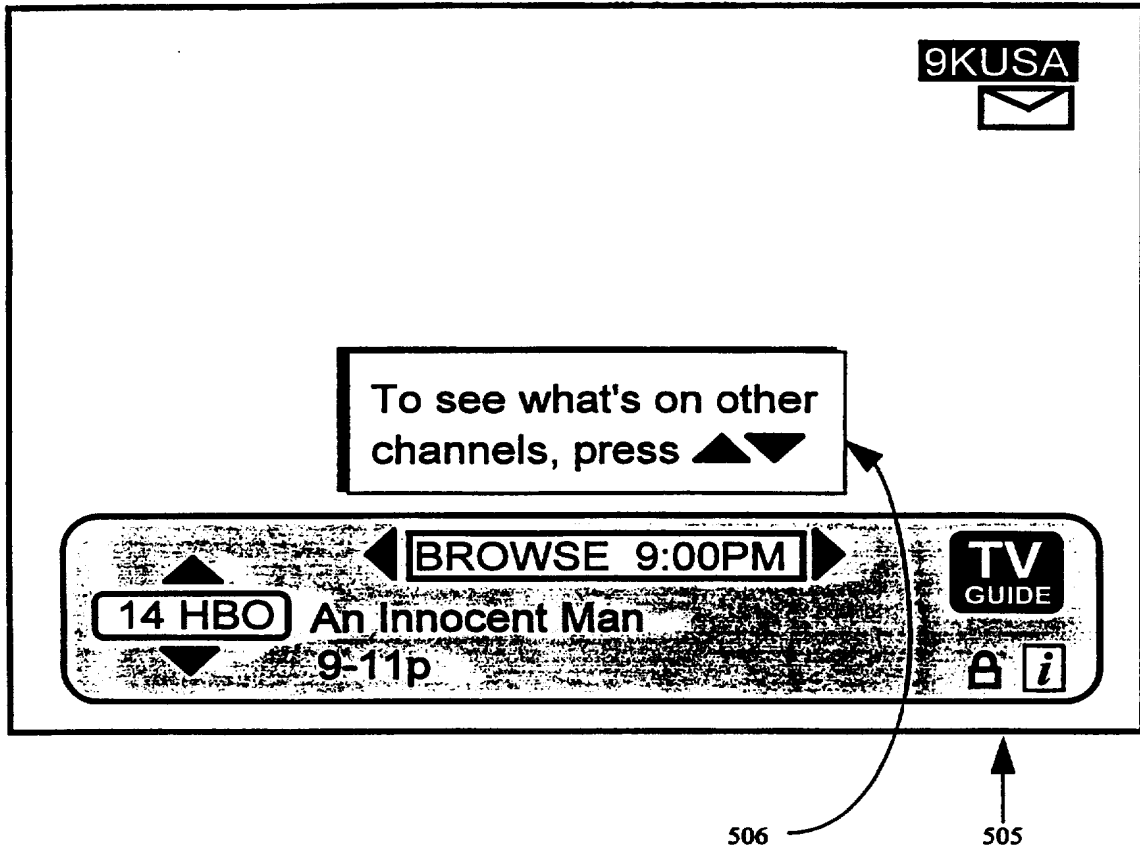

Fig. 44B

65/71

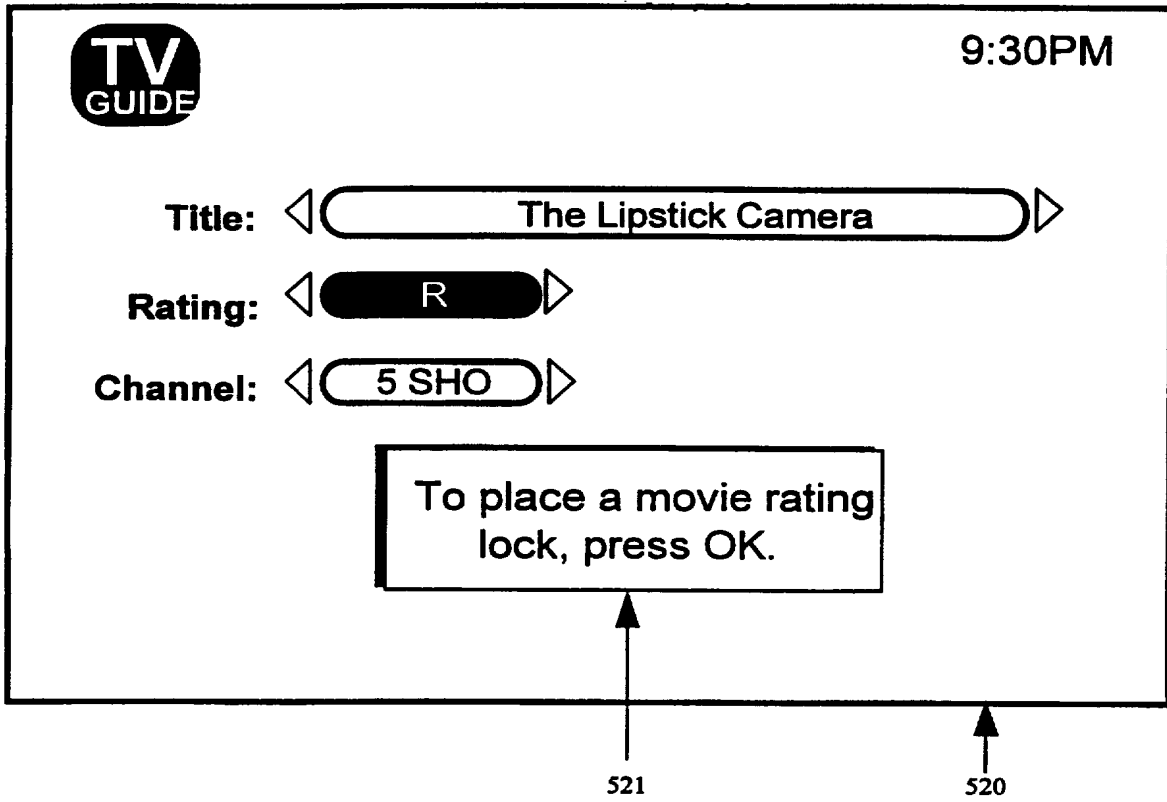

Fig. 45A

66/71

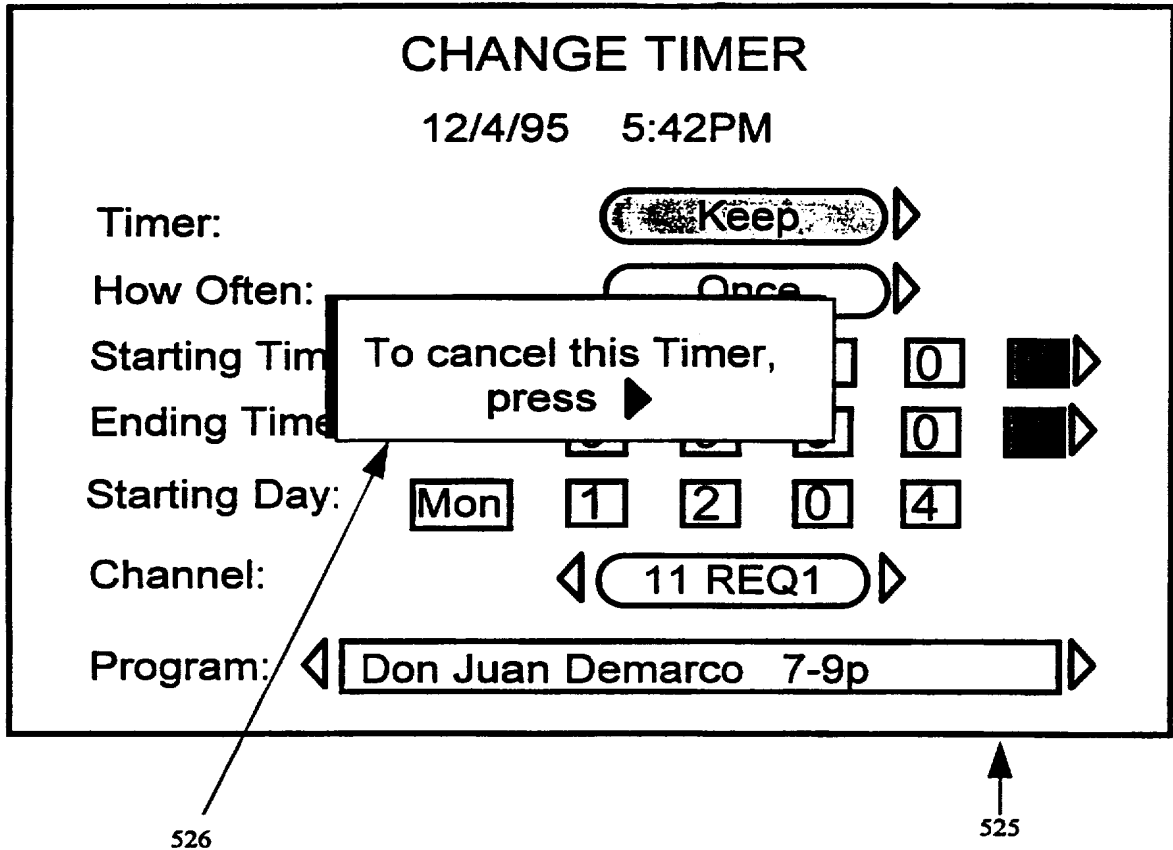

Fig. 45B

67/71

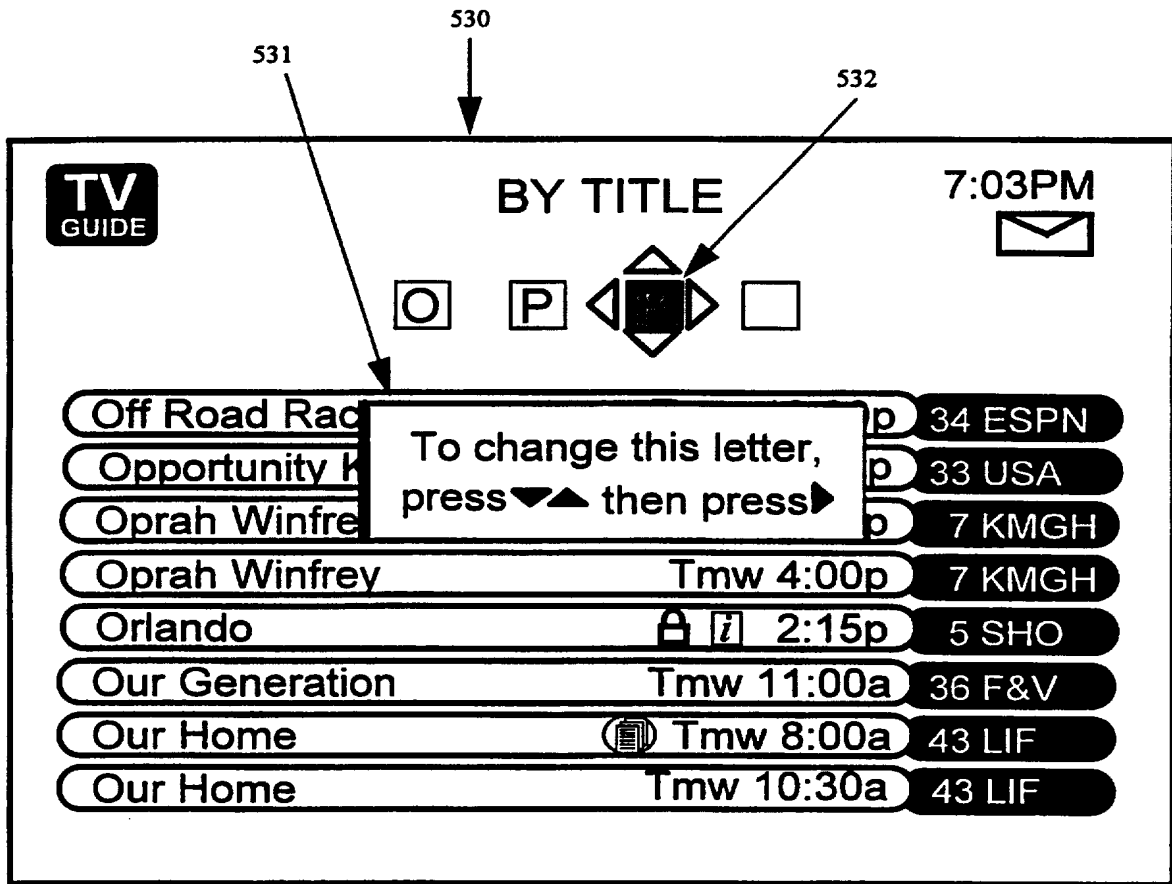

Fig. 45C

68/71

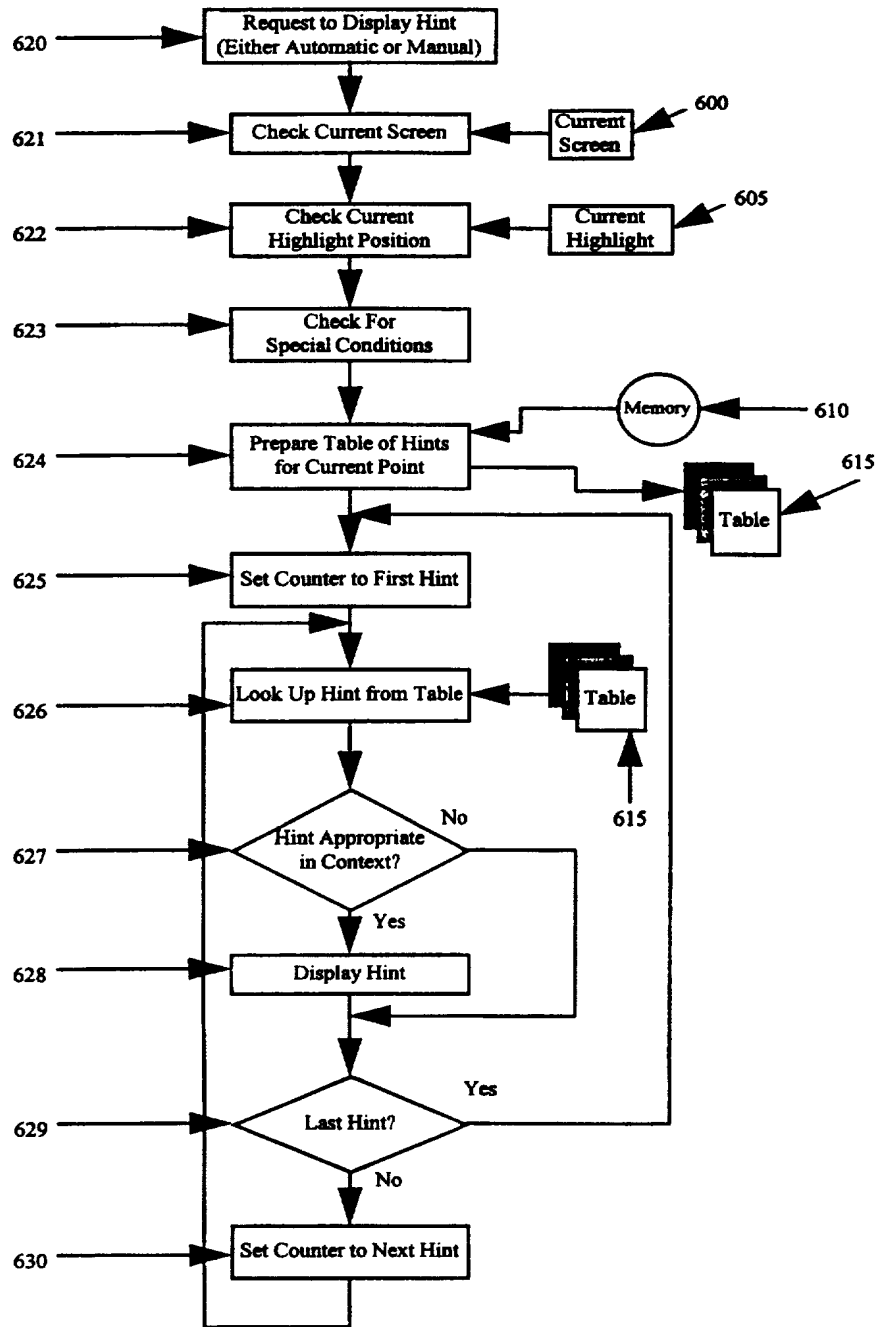

Fig. 46

69/71

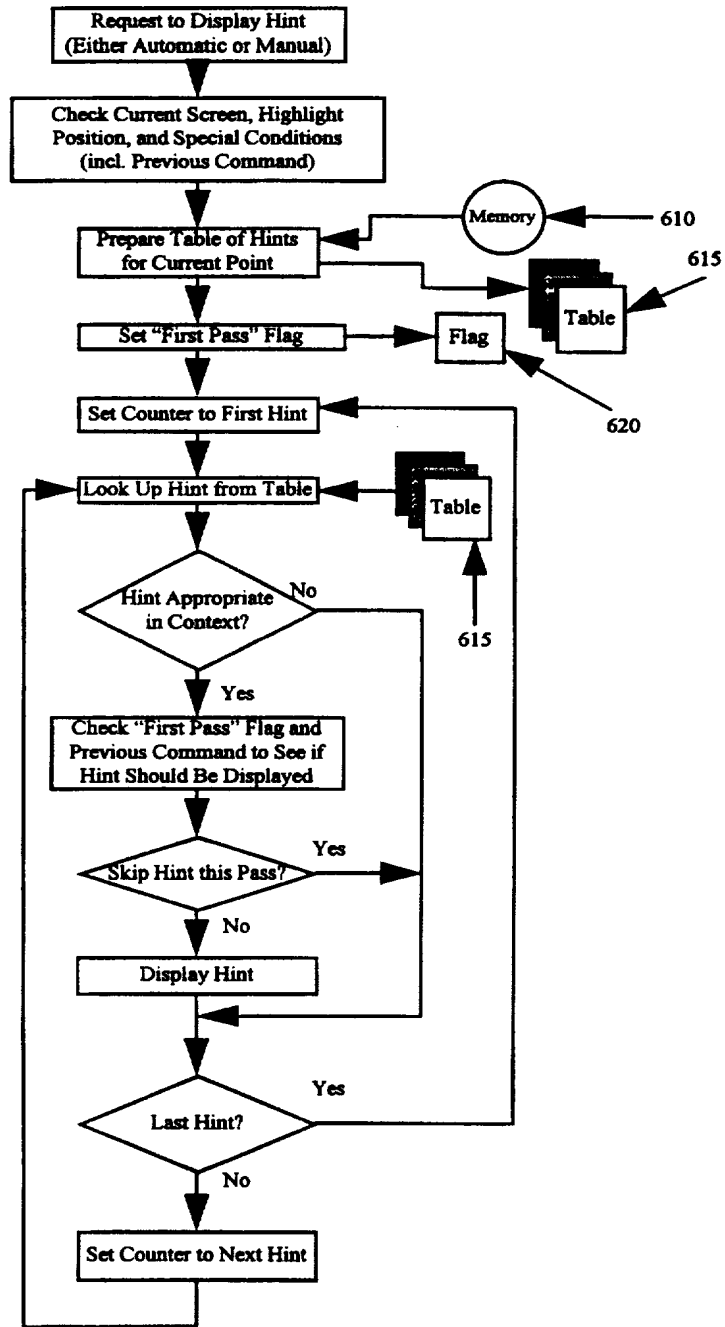

Fig. 47

70/71

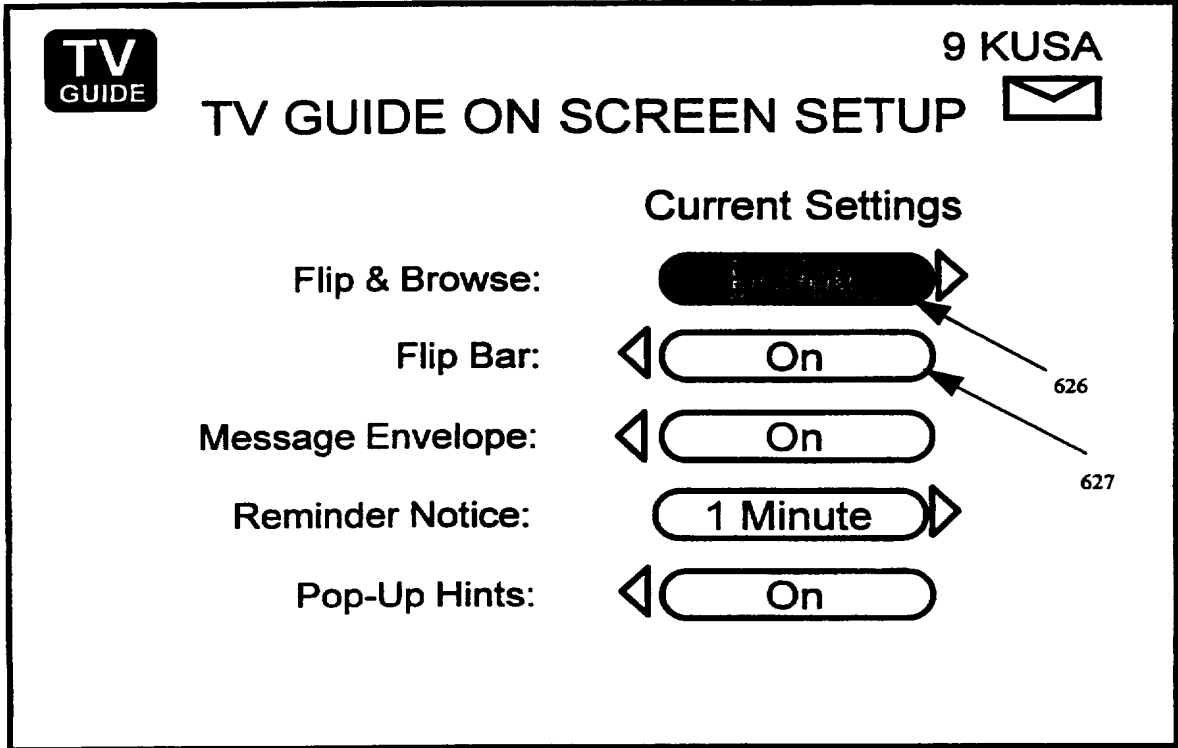

Fig. 48

71/71

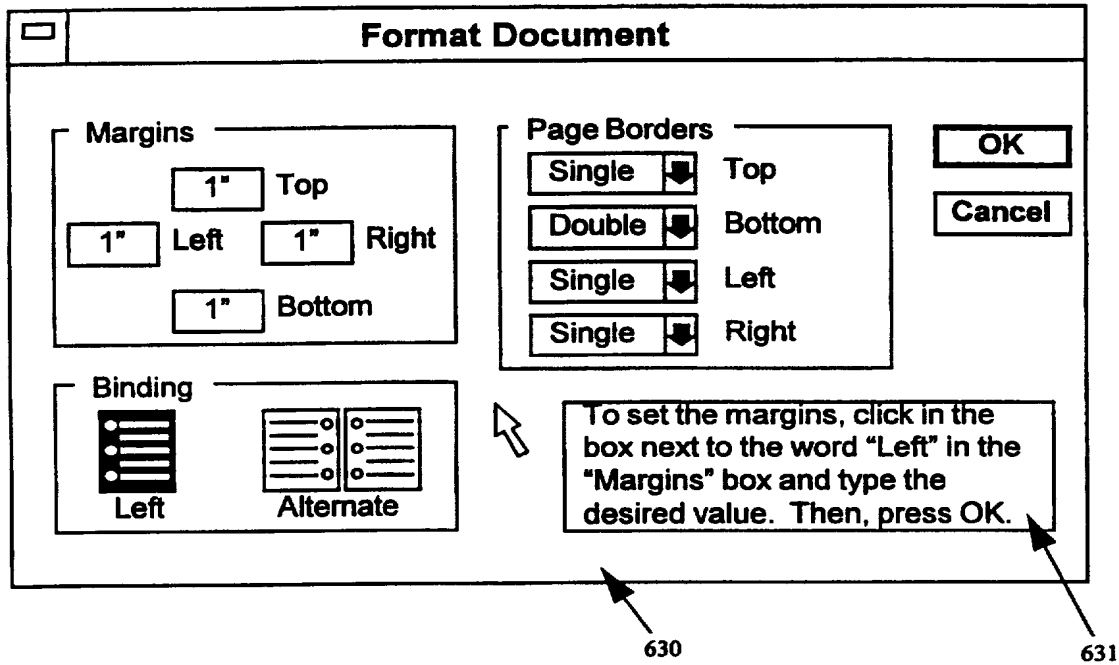

Fig. 49

INTERNATIONAL SEARCH REPORT

Intern. Application No
PCT/US 97/09703

| | | | | |
|--------------------------------------------------------------------------------------------------------------------------------------------------------------------------------------------------------------------------------------------------------------------------------------------------------------------------------------------------------------------------------------------------------------------------------------------------------------------------------------------------------------------------------------------------------------------------------------------------------------------------------------------------------------------------------------------------------------------------------------------------------------------------------------------------------------------------------------------------------------------------------------------------------------------------------------------------------------------------------------------------------------------------------------------------------------------------------------------------------------------------------------------------------------------------------------------------------------------------------------------------------------------------------------------------------------------------------------------------------------------------------------------------------------------------------------------------------------------------------------------------------------------------------------------------------------------------------------------------------------------------------------------------------------------------------------------------|-------------------------------------------------------------------------------------------------------------------------------------------------------------------------------------------------------------------------------------------------------------------------------------------------------------------------------------------------------------------------------------------------------------------------------------------------------------------------------------------------------------------------------------------------------------------------------------------------------------------------------------------------------------------------------------------|-----------------------------------------------------------------------------------------------------|---------------------------------------------------------------------------------------------------------------------------------------------------------------------------------------------------------------------------------------------------------------------------------------------------------------------------------------------------------------------------------------------------------------------------------------------------------------------------------------------------------------------------------------------------------------|-------------------------------------------------------------------------------------------------------------------------------------------------------------------------------------------------------------------------------------------------------------------------------------------------------------------------------------------------------------------------------------------------------------------------------------------------------------------------------------------------------------------------------------------------------------------------------------------------------------------------------------------------------------------------------------------|
| A. CLASSIFICATION OF SUBJECT MATTER IPC 6 H04N7/173 | | | | |
| According to International Patent Classification (IPC) or to both national classification and IPC | | | | |
| B. FIELDS SEARCHED | | | | |
| Minimum documentation searched (classification system followed by classification symbols) IPC 6 H04N | | | | |
| Documentation searched other than minimum documentation to the extent that such documents are included in the fields searched | | | | |
| Electronic data base consulted during the international search (name of data base and, where practical, search terms used) | | | | |
| C. DOCUMENTS CONSIDERED TO BE RELEVANT | | | | |
| Category * | Citation of document, with indication, where appropriate, of the relevant passages | Relevant to claim No. | | |
| A | WO 94 14282 A (DISCOVERY COMMUNICATIONS INC) 23 June 1994 see page 5, line 22 - page 9, line 14 see page 70, line 27 - page 72, line 7; figure 14 see page 92, line 21 - page 93, line 9; figure 28E --- -/-- | 1-4,7, 11,18, 19, 22-24, 27, 32-34, 37,41, 43, 47-49, 51-53, 56,58,61 | | |
| <input checked="" type="checkbox"/> Further documents are listed in the continuation of box C. | | | | |
| <input checked="" type="checkbox"/> Patent family members are listed in annex. | | | | |
| * Special categories of cited documents : | | | | |
| <table style="width: 100%; border: none;"> <tr> <td style="width: 50%; border: none; vertical-align: top;"> *A* document defining the general state of the art which is not considered to be of particular relevance *E* earlier document but published on or after the international filing date *L* document which may throw doubts on priority claim(s) or which is cited to establish the publication date of another citation or other special reason (as specified) *O* document referring to an oral disclosure, use, exhibition or other means *P* document published prior to the international filing date but later than the priority date claimed </td> <td style="width: 50%; border: none; vertical-align: top;"> *T* later document published after the international filing date or priority date and not in conflict with the application but cited to understand the principle or theory underlying the invention *X* document of particular relevance; the claimed invention cannot be considered novel or cannot be considered to involve an inventive step when the document is taken alone *Y* document of particular relevance; the claimed invention cannot be considered to involve an inventive step when the document is combined with one or more other such documents, such combination being obvious to a person skilled in the art. *&* document member of the same patent family </td> </tr> </table> | | | *A* document defining the general state of the art which is not considered to be of particular relevance *E* earlier document but published on or after the international filing date *L* document which may throw doubts on priority claim(s) or which is cited to establish the publication date of another citation or other special reason (as specified) *O* document referring to an oral disclosure, use, exhibition or other means *P* document published prior to the international filing date but later than the priority date claimed | *T* later document published after the international filing date or priority date and not in conflict with the application but cited to understand the principle or theory underlying the invention *X* document of particular relevance; the claimed invention cannot be considered novel or cannot be considered to involve an inventive step when the document is taken alone *Y* document of particular relevance; the claimed invention cannot be considered to involve an inventive step when the document is combined with one or more other such documents, such combination being obvious to a person skilled in the art. *&* document member of the same patent family |
| *A* document defining the general state of the art which is not considered to be of particular relevance *E* earlier document but published on or after the international filing date *L* document which may throw doubts on priority claim(s) or which is cited to establish the publication date of another citation or other special reason (as specified) *O* document referring to an oral disclosure, use, exhibition or other means *P* document published prior to the international filing date but later than the priority date claimed | *T* later document published after the international filing date or priority date and not in conflict with the application but cited to understand the principle or theory underlying the invention *X* document of particular relevance; the claimed invention cannot be considered novel or cannot be considered to involve an inventive step when the document is taken alone *Y* document of particular relevance; the claimed invention cannot be considered to involve an inventive step when the document is combined with one or more other such documents, such combination being obvious to a person skilled in the art. *&* document member of the same patent family | | | |
| Date of the actual completion of the international search 25 September 1997 | Date of mailing of the international search report - 3. 10. 97 | | | |
| Name and mailing address of the ISA European Patent Office, P.B. 5818 Patentlaan 2 NL - 2280 HV Rijswijk Tel. (+ 31-70) 340-2040, Tx. 31 651 epo nl, Fax (+ 31-70) 340-3016 | Authorized officer Fuchs, P | | | |

INTERNATIONAL SEARCH REPORT

Inter. Application No

PCT/US 97/09703

C.(Continuation) DOCUMENTS CONSIDERED TO BE RELEVANT

| Category | Citation of document, with indication, where appropriate, of the relevant passages | Relevant to claim No. |
|----------|------------------------------------------------------------------------------------------------------------------------------------------------------------------------------------------------------------------------------------------------------------------------------------------------------------------------------------------------------------------------------------------------------------|----------------------------------------------------------------------------------------------------------------------------------------------------------------------------------------------------------------|
| A | <p>KINGHORN J R: "ENHANCED ON-SCREEN DISPLAYS FOR SIMPLER TV CONTROL" 1 August 1992 , IEEE TRANSACTIONS ON CONSUMER ELECTRONICS, VOL. 38, NR. 3, PAGE(S) 725 - 733 XP000311917</p> <p>see page 731, right-hand column, line 1 - page 732, left-hand column, line 11; figures 17,18</p> <p style="text-align: center;">-----</p> | <p>1,11,18, 19,22, 24, 32-34, 41,48, 49,52, 53,56,61</p> |

INTERNATIONAL SEARCH REPORT

Information on patent family members

International Application No
PCT/US 97/09703

| Patent document cited in search report | Publication date | Patent family member(s) | Publication date |
|-------------------------------------------|---------------------|----------------------------|---------------------|
| WO 9414282 A | 23-06-94 | AU 5732994 A | 04-07-94 |
| | | AU 5733094 A | 04-07-94 |
| | | AU 5733194 A | 04-07-94 |
| | | AU 5733294 A | 04-07-94 |
| | | AU 5736394 A | 04-07-94 |
| | | AU 5845894 A | 22-06-94 |
| | | AU 5869894 A | 04-07-94 |
| | | CA 2151458 A | 23-06-94 |
| | | CN 1093211 A | 05-10-94 |
| | | CN 1090451 A | 03-08-94 |
| | | CN 1090452 A | 03-08-94 |
| | | CN 1096151 A | 07-12-94 |
| | | CN 1090453 A | 03-08-94 |
| | | CN 1090454 A | 03-08-94 |
| | | EP 0673578 A | 27-09-95 |
| | | EP 0673579 A | 27-09-95 |
| | | EP 0673580 A | 27-09-95 |
| | | EP 0673581 A | 27-09-95 |
| | | EP 0673582 A | 27-09-95 |
| | | EP 0673583 A | 27-09-95 |
| | | EP 0674824 A | 04-10-95 |
| | | IL 107908 A | 10-01-97 |
| | | IL 107909 A | 15-04-97 |
| | | IL 107910 A | 10-06-97 |
| | | IL 107912 A | 18-02-97 |
| | | IL 107913 A | 15-04-97 |
| | | JP 8510869 T | 12-11-96 |
| | | JP 8506938 T | 23-07-96 |
| | | JP 8506939 T | 23-07-96 |
| | | JP 8506940 T | 23-07-96 |
| | | JP 8506941 T | 23-07-96 |
| | | JP 8506942 T | 23-07-96 |
| | | NZ 259146 A | 26-05-97 |
| | | NZ 259147 A | 26-05-97 |
| | | NZ 259148 A | 26-11-96 |
| | | WO 9413107 A | 09-06-94 |
| | | WO 9414279 A | 23-06-94 |
| | | WO 9414280 A | 23-06-94 |
| | | WO 9414281 A | 23-06-94 |
| | | WO 9414283 A | 23-06-94 |

INTERNATIONAL SEARCH REPORT

Information on patent family members

Interr. Application No

PCT/US 97/09703

| Patent document cited in search report | Publication date | Patent family member(s) | Publication date |
|----------------------------------------|------------------|-------------------------|------------------|
| WO 9414282 A | | WO 9414284 A | 23-06-94 |
| | | US 5559549 A | 24-09-96 |
| | | US 5600364 A | 04-02-97 |
| | | US 5659350 A | 19-08-97 |
| ----- | | | |